



PRODUCT OVERVIEW FOR STRUCTURAL WATERPROOFING

BUILDING TRUST





Contents

Product Overview for Structural Waterproofing

■ Tricoflex® Bonded Sealing System	4 - 9
Tricoflex® sealing strips	
Tricoflex® sealing profiles	
Typical applications and uses	
■ Injection Technology	10 - 13
SikaFuko® VT injection hose	
SikaFuko® Eco 1 injection hose	
Injection materials	
■ Sikaswell® Swelling Products	14 - 17
SikaSwell® swelling profiles	
SikaSwell® swelling adhesive sealant	
SikaSwell® swelling rings/plugs	
■ Sika® Waterbars	18 - 39
Overview	20 - 23
Calculation diagram acc. to DIN 18197	24 - 25
Sika® Waterbars PVC-P	26 - 27
Sika® Tricomer® Waterbars	28 - 29
Sika® Elastomer® Waterbars	30 - 31
Sika® WESTEC® Waterbars	32 - 33
Sika® Special Waterbars	34 - 36
■ Sika® Waterbars For Flanging Constructions	36 - 41
Overview	
Connections from new to existing structures	
Waterproofing of existing joints	
■ Sika® KAB Combination System	42 - 45
■ Sika® Crack Inducing Tubes SR	46
■ Sika® Metalsheet FBV	47
■ Sika® Compression Seals	48
■ Sika® Maro Pipe Waterproofing System	49
■ Prefabricated Standard Junctions	50
■ Prefabricated Waterbar Systems	51
■ Equipment, Tools and Accessories	52 - 55
■ Waterbar Specification	56 - 57
■ Waterbar Handling Guidelines	58
■ Waterbar Installation Guidelines	59 - 61
■ Additional Information	62

Tricoflex®

Bonded Sealing System

Easy joint sealing and detailing solutions



Tricoflex® Bonded Sealing System

Easy sealing and detailing solutions

Advantages of the Tricoflex® system

- Ideal solution for watertight sealing between pre-cast elements, double wall joints, light walls and joints separate structures, transitions between different materials e.g. reinforced concrete to concrete blocks, plus for many types of joint and crack repairs etc.
- The specially developed, solvent-free, epoxy resin based, system adhesive is also suitable for use on damp substrates.
- The system adhesive has excellent bond to concrete, steel, brick, wood, various plastics and most other commonly used construction materials.
- A completely homogeneous joint sealing and waterproofing system using highly flexible, next generation Thermo-plastic Elastomer (TPE) membrane that combines the best performance characteristics of thermo-plastics (e.g. PVC) and elastomers (e.g. EPDM), resulting in an elongation at break > 400%

Installation

The Tricoflex® bonded sealing system is extremely easy to use. The substrate must be clean, sound with no loose or friable material, and free from any contaminants. The Tricoflex® system is applied in 5 simple steps, which are shown in the pictures.



■ 1. Mixing the Tricoflex® FU 60 system adhesive



■ 2. Applying the base layer of adhesive



■ 3. Positioning the membrane strip



■ 4. Joining membrane strips by heat welding



■ 5. Applying the top layer of adhesive

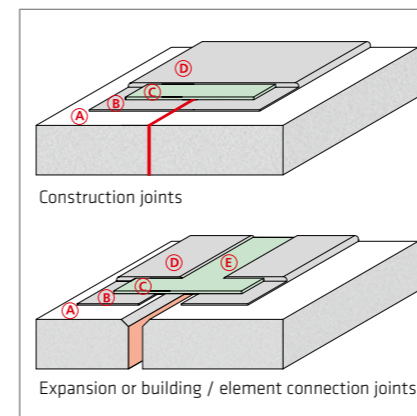
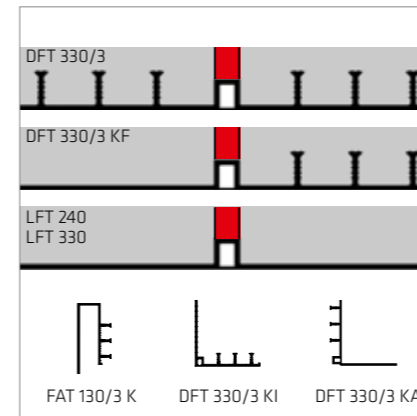

Tricoflex® TPE sealing strips	Total membrane width	Membrane thickness	Roll length	Adhesive consumption [kg/m]*
For Expansion joints				
Tricoflex® 200/2	200	2	20	2,0
Tricoflex® 250/2	250	2	20	2,4
Tricoflex® 300/2	300	2	20	2,8
For Construction joints				
Tricoflex® 150/1	150	1	20	1,6
Tricoflex® 200/1	200	1	20	2,0
Tricoflex® 250/1	250	1	20	2,4

■ The Tricoflex® TPE membrane is available in widths from 100 mm to 2000 mm on request.

* Typical values

Tricoflex® sealing profiles	Total width part	Width of expansion	Membrane thickness	Profile height	Number anchoring ribs	Adhesive consumption [kg/m]*
For bonding to or casting in to seal joints in and between elements						
DFT 330/3	330	104	4	30	6	
DFT 330/3 KF	330	104	4	30	3	3,5
LFT 240	240	-	4	--	5 - 5	
LFT 330	330	-	4	--	5 - 6	
FAT 130/3 K	Profile height 180 mm, top plate 30 mm, stopend anchor (f) 35 mm					
DFT 330/3 KI	As DFT 330/3 KF but angled					3,5
DFT 330/3 KA	As DFT 330/3 KF but angled					3,5

■ For bonding to hardened surfaces to seal movement and construction joints between buildings and/or precast elements, plus can also be cast into site-placed concrete to seal many different types of joints

* Typical values

Additional system components

System components

- System adhesive - Tricoflex® FU 60

Ancillary materials and equipment as required

- Sika® Thinner C / Sika® Colma® Cleaner
- Membrane strip welding cord
- Suitable heat welding equipment and accessories

System structure: Watertight against water under hydrostatic pressure

- A: Concrete substrate
- B: Base layer of Tricoflex® FU 60 system adhesive
- C: Tricoflex® sealing strip
- D: Top layer of Tricoflex® FU 60 system adhesive
- E: For expansion joints: An additional expansion area to accommodate larger joint movement is also possible (e.g. Omega 'Ω' loop installation)

System structure: Watertight against water not under pressure (e.g. damp soil, percolating water etc.)

- The complete top surface layer of Tricoflex® FU 60 adhesive can be omitted and only the end anchoring parts must be covered

Tricoflex® Bonded Sealing System

Typical applications and uses



Precast basement elements - connection joint waterproofing

Requirement:
Watertight sealing of the base joints, connection joints and service penetrations against water under hydrostatic pressure

Method:

- For the base floor/wall joints
Installation of Tricoflex® 150/1 sealing membrane strips directly on and over the angle
- For the vertical wall/wall joints
Installation of Tricoflex® 150/1 directly on the units over the joints
- Detailing and sealing
 - Filling the tie-rod holes with adhesive and over-banding where necessary
 - Sealing around pipe penetrations with pre-formed collar strips



Connecting a new building to an existing structure

Requirement:
This new building structure had to be connected at the foundations with a watertight joint to the adjacent existing structure

Method:

- Tricoflex® DFT 330/3 KF waterstop profiles were prefabricated into DFT 330/3 KI angle sections and bonded with the adhesive in a watertight connection to the existing structure. The free, profiled leg of the waterstopping profile was then cast into the new concrete.



Precast concrete bridge elements - connection joint waterproofing

Requirement:
The foundations were a reinforced concrete raft and base slab cast insitu. The vertical sides were then produced using precast concrete sections and the joints between them had to be made durably watertight

Method:

- All of the joints between the precast wall sections were easily and simply made watertight with the Tricoflex® bonded sealing system



Joint repairs inside a secondary clarifier treatment tank

Requirement:
To replace the deteriorated existing joint sealant, with limited access and angled joint runs, with a system to withstand exposure to aggressive wastewater under hydrostatic pressure and additional mechanical loading from the treatment process

Method:

- Installation of Tricoflex® LFT 240 profiles, which are designed for use against higher water pressures and mechanical loading
- The sealed joints were then protected from accidental mechanical damage with a sliding cover plate (fixed one-side)



Sports stadium terrace deck - wide joint waterproofing

Requirement:
Waterproofing of joints in the stadium terraces with movement capabilities of up to 5 cm, plus complex joint configurations and difficult runs (e.g. large numbers of edges in different planes)

Method:

- Installation of the Tricoflex® membrane strip with a pre-formed central loop into the joints (giving the security of additional movement capability in addition to the 400% elongation at break performance of the membrane)
- Covering of the joints in trafficked areas with a sliding cover plate (fixed one-side only)



Expansion joint waterproofing in a shaft

Requirement:
Post-construction waterproofing of the expansion joints in the difficult access and working conditions with restricted space

Method:

- Prefabrication of Sika® Tricoflex® LFT 330 waterstop profile to suit the structure, then simple butt welding in the shaft to form a reliable watertight seal



Expansion joint waterproofing on an insitu poured concrete structure

Requirement:
Very rough concrete surfaces and joints with large movement capabilities of up to 4 cm

Method:

- Installation of the Tricoflex® membrane with a top layer of adhesive only on the bonded edges of the strip, not in the central expansion area, so the system can easily accommodate the anticipated movement and more



Waterproofing for typical detailing solutions

Requirement:
Secure watertight detailing solutions around pipe penetrations (e.g. for utility pipe entries and service ducts etc.), plus around clamped seals in flanged waterstops etc.

Method:

- Easy detailing and sealing with Sika® Tricoflex pipe collars and profile systems

Injection Technology

Approved injection systems, proven for many years



Injection Technology

Injection hoses and injection materials

Injection technology

Watertight joint and crack sealing by injection is based on approved, tested and well proven technologies. The basis for any successful injection project is to select the right injection material and equipment, then to carry out the injection process professionally. The technical suitability and economic advantages of the alternative materials, whether polyurethane, acrylate resins or mineral-based injection products, all have to be assessed for each individual project.

Injection technology generally works on the principle known as grouting and is now an indispensable part of both structural repair works and planned structural waterproofing. With the aid of injection packers (ports) and hoses, any voids and other defects in the concrete can be effectively and efficiently grouted, filled and sealed with a wide variety of methods and materials.

SikaFuko® VT injection hoses - when secure watertightness is required

This unique design with an integral valve system guarantees maximum security. In the concreting process the neoprene strips seal the future outlets securely and prevent cement paste entering the hose. In the grouting process these neoprene strips are compressed and the injection material can escape through the preformed slots along the length of the hose. With the right injection material, vacuum pressure cleaning allows grouting to be repeated in the event of future leaks or damage.

SikaFuko® Eco injection hoses - a cost effective solution

An extremely cost effective standard injection hose system that has been approved and widely used for many years. It is most suitable for single and repeat grouting with polyurethane resins, cement suspensions and acrylate gels.

Injection materials

Acrylate resins

- Miscible with water, therefore usable for repeat grouting with suitable injection hoses
- Can be used and react at low temperatures (>50C)
- Can have additional swelling ability for additional security, e.g. in crack movement
- The reaction time is adjustable to suit the specific problem and project requirements

Polyurethane resins

- Provide excellent edge adhesion on dry, damp and even wet surfaces
- Suitable for grouting water-bearing cracks in combination with waterstopping PU foam
- Cures to a shrinkage-free, permanently elastic, durable polymer
- Suitable for flexible filling and watertight grouting of concrete voids, cracks, defects and construction joints through injection packers and pre-installed hoses

Cement suspensions

- Economic injection materials that are ideal for projects with high volume material demands
- Miscible with water, therefore usable for repeat grouting with suitable injection hoses
- Special additive components give improved grout flow and pressure stability properties

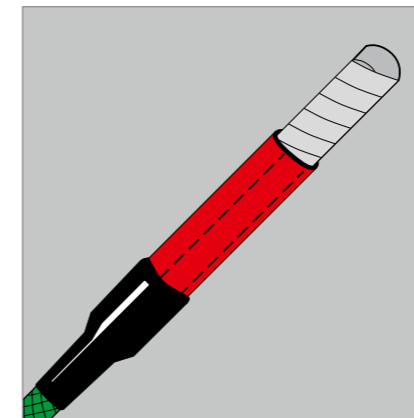
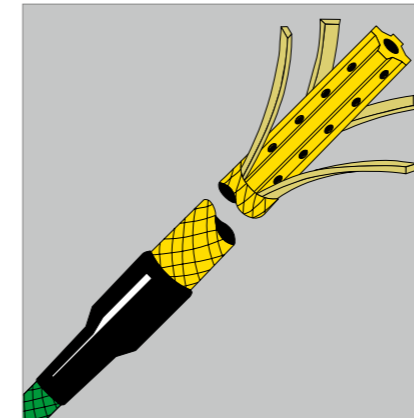

SikaFuko® VT injection hose Re-injectable	Ø Hose diameter	PUR-resin	EP-resin*	Acrylate-resin*	Cement-suspension*	Cement-paste*
SikaFuko® VT 1	6	x	x	⊗	⊗	-
SikaFuko® VT 2	10	x	x	⊗	⊗	⊗
x For single injection		⊗ For repeat injection (vacuumable)		- Not recommended		
Packaging:						
■ Combi-pack - various combined packaging units with all fixing and installation accessories included						
■ Rolls on disposable reels						

SikaFuko® Eco 1 injection hose Re-injectable	Ø Tube diameter	PUR-resin	EP-resin*	Acrylate-resin*	Cement-suspension*	Cement-paste*
SikaFuko® Eco 1	6	x	x	⊗	⊗	-
x For single injection		⊗ For repeat injection (vacuumable)		- Not recommended		
Packaging:						
■ Combi-pack - various combined packaging units with all fixing and installation accessories included						
■ Rolls on disposable reels						

Service to be performed by service provider

- Assembly
- Installation and Fixing
- Injection Grouting

Sika® Injection materials	No. of components	Pot life min.	Hose injection	Crack injection	Gelling ability	Water-stopping
Acrylate resin/gel						
Sika® Injection-304	3	0,5 - 2			x	x
Sika® Injection-306	3	8 - 50	x		x	x
Sika® Injection-307	3	5 - 50	x	x	x	
Polyurethane resin/foam						
Sika® Injection-201 CE	2	70	x	x		
Sika® Injection-101 RC	2	-		x		x
Sika® Injection-107	1	70		x		
Cement suspension, micro-cement based						
Tricodur® SI	2	60	x	x		
Tricodur®	1	60		x		

SikaSwell®

Swelling Products

Active joint waterproofing systems

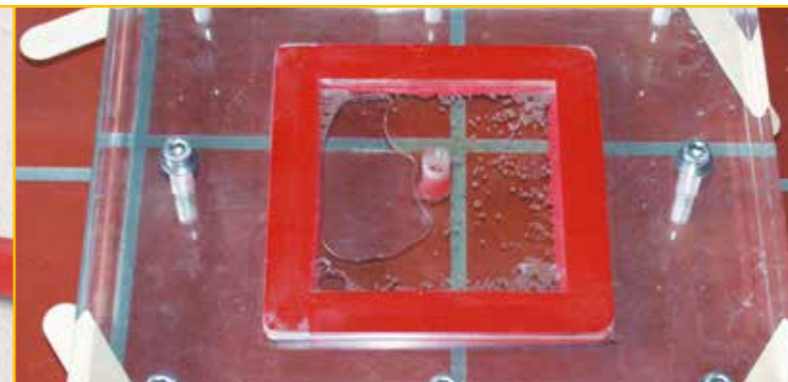

SikaSwell® Swelling Products

Profiles, adhesive sealants and combination systems

SikaSwell® swelling products

Swelling products are also known as active waterproofing systems because they swell and develop pressure in contact with water, which blocks the path and prevents water penetration through the joint. The advantages of these products are their ease of handling and economy. Swelling products are suitable for sealing construction joints and many types of detailing, plus for secondary or back-up sealing systems e.g. in combination with injection hoses and waterbars.

- For construction joints, wall penetrations, connections between different materials
- Reliable, reversible swelling capabilities
- Outstanding chemical resistance
- Easy and fast installation
- Extremely high long term durability

Swelling product types			Waterproofing of
Swelling profiles	Acrylate based	Shape-maintaining Reversible swelling	Construction joints and around penetrations
	Bentonite based	Long worldwide experience Reversible swelling	
Swelling profile rings and plugs	Acrylate based	Shape-maintaining Reversible swelling	Fibre cement ducts, plastic pipes/ducts, anchor bars
Swelling adhesive sealants	Polyurethane based	1-component products Curing in 24 h	Construction joints and around penetrations
Combination products	Combination construction joint waterstops (KAB)	Combination of waterbar and swelling material	Secure construction joints and shrinkage / crack inducing joint systems

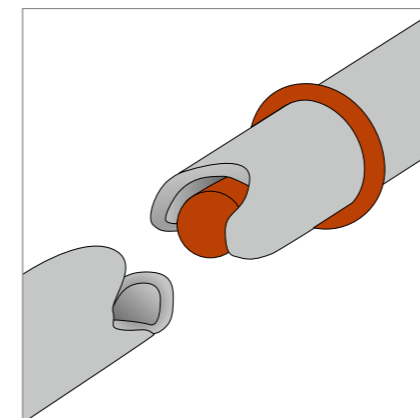
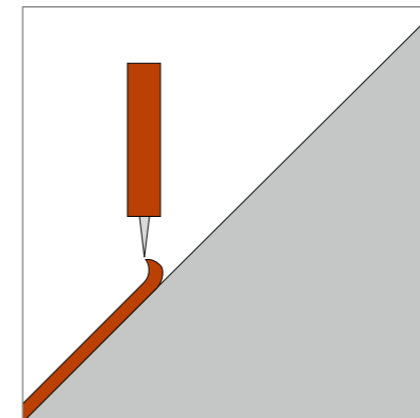
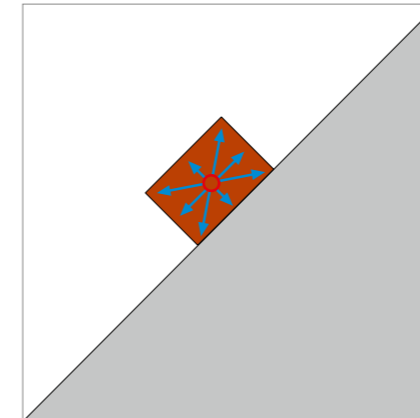

SikaSwell® swelling profiles	Profile height	Profile width	Swelling in water %	Fixing method MK adhesive	Clips/mesh
Acrylate based					
SikaSwell® A 2010	10	20	ca. 200	x	
SikaSwell® A 2015	15	20	ca. 200	x	
SikaSwell® A 2025	25	20	ca. 200	x	

■ Swelling details are guide values and may vary due to site conditions
 ■ Easy and secure fixing with SikaBond AT-Universal or SikaSwell-S2 adhesive
 ■ Packaging units
 Typ 2010, 20 mm x 10 mm, 1 box = 60 m / 6 rolls
 Typ 2015, 20 mm x 15 mm, 1 box = 56 m / 8 rolls
 Typ 2025, 20 mm x 25 mm, 1 box = 30 m / 6 rolls

SikaSwell® adhesive sealant	No. of components	Packaging	Swelling in water %	Curing time
Polyurethane based				
SikaSwell® swelling paste Type E	1	Cartridge	ca. 250	24 h

Accessory for SikaSwell® swelling paste Type E sealant:

- Manual cartridge gun

SikaSwell® swelling rings	Inside diameter	Waterproofing of
SikaSwell® swelling ring	43	Fibre cement ducts
SikaSwell® swelling ring	26	Plastic pipes and ducts
SikaSwell® swelling ring	18	Anchor bars

SikaSwell® swelling plugs		
SikaSwell® swelling plug	23	Fibre cement ducts
SikaSwell® swelling plug KS	23	Plastic pipes

Sika® Waterbars

System solutions for watertight sealing of expansion and construction joints



Sika® Waterbars

System solutions for watertight sealing of expansion and construction joints

Joint waterproofing has been successfully achieved in watertight concrete structures by using engineered waterbars as waterstops for very many years. In fact these waterbars are now often widely known as 'waterstops' in many places. Since the early 1950's building basements and civil engineering structures have used such waterstops for secure waterproofing systems for structural joints exposed to high stress.

Today these waterbars are available based on different materials and in a wide variety of profiles and cross-sections for the equal diversity of watertight sealing and waterstopping functions that are required. In different types of structure there are different types of exposure and stress, with special waterbars also produced for specific exposure requirements, such as extremely high water pressures or where the waterstopping system itself must also be in contact with aggressive substances.

In Germany such waterstop systems are divided into DIN-regulated and unregulated types. Since 1982 Elastomer waterbars have been covered by DIN standard 7865, part 1: Shapes and dimensions, and part 2: Material requirements and testing. A new edition of the standard came into force in February 2015. Tricomer (PVC-P/NBR) waterstops are covered by DIN 18541, part 1: Concepts, shapes, dimensions, marking, and part 2: Material requirements, testing and inspection, first edition 1992 and new edition January 2018.

Sika PVC-P Waterbars are manufactured to Sika's own in-house standards and also meet the form and material requirements of the DIBt (German institute for Civil Engineering) with an abP Certificate for use in construction projects.

The planning and design, joint formation, handling and installation of regulated Tricomer and Elastomer waterbars are governed by DIN 18197: Sealing of joints in concrete with waterbars. The National Technical Approval for Sika PVC-P waterbars also relates to this application standard as regards the products manufacture, design and use, including modifications. German standards and guidelines also exist and apply to specific engineered joint waterproofing applications e.g. for use in bridges, tunnels, locks and dams.

Waterstop solutions produced with all of the above types of waterbar now represent the most proven system solutions for the waterproofing of expansion and construction joints in watertight concrete structures. These solutions also have the longest track record and are covered by detailed instructions for their manufacture, design and installation to established standards and guidelines. The use of these prefabricated waterstop systems with factory welded joints that minimize the need for site joints, also gives the highest level of watertight joint security and reliability.

Sika® Waterbars

Material descriptions and approvals

PVC-P

- plasticized polyvinyl chloride for Sika PVC-P waterbars

The advantages of this material are its suitability for the waterstopping system in many applications; it can be easily heat welded and is relatively low cost. Its tensile strength is 8 MPa minimum and its elongation at break is 275% min. The products are "Not compatible with bitumen" (PVC/NB). They have proved effective over many decades. The waterstops are thoroughly tested and have an individual DIBt Approval Certificate (abP).

- Approval/Compliance:
abP Approval Certificate

PVC-P + Q

- PVC-P waterbars with a swelling section for Sika® combination (KAB) waterbars

The material used for KAB construction joint waterbars is a special PVC-P with high Shore hardness, which gives it very good positional stability that is combined with high elongation capability.

These waterbars are completed by integrated swelling sections to give dual-action waterproofing functions with a very high sealing effect.

- Approval/Compliance:
abP - Approval Certificate
WU Guidelines for Watertight Structures (DafStb)

PVC/NBR

- PVC-P/NBR polymer, for Sika® Tricomer® waterbars

This special polymer was developed in our own laboratories and consists of very high quality base materials which exceed the requirements of the standards in many aspects. Tricomer® has permanent elasticity similar to elastomer, plus outstanding chemical and ageing resistance. Its elongation at break is over 350% and its tensile strength min. 10 MPa. All Tricomer® waterbars are produced in not bitumen resistant quality (NB). External Tricomer® waterbars can be also produced in bitumen compatible (BV) quality on request. They can be heat welded and are well proven.

- Approval/Compliance:
Meets Standards DIN 18541 and DIN 18197, plus abP
Certified for clamped flanged seals

Elastomer

for Sika® Elastomer waterbars

Elastomers are open-pored, cross-linked polymers which become an elastic material by the process of vulcanization. Therefore these profiles must also be joined together by vulcanizing. Elastomers are extremely ductile (elongation at break $\geq 380\%$) with outstanding elastic recovery. For this reason elastomer waterstops are mainly used for larger joints and joints with larger movement requirements such as with frequent load changes, low temperatures and/or high water pressures.

- Approval/Compliance:
Meets Standards DIN 7865 and DIN 18197

Thermoplastic polyolefin (FPO) for Sika® Eco waterbars

This FPO material is fully tested in accordance with German DVGW criteria in worksheet W 270 and the German KTW recommendations and is approved as meeting all of the requirements for plastics to be used in contact with drinking water (potable) or foodstuffs.

- Approval/Compliance:
Drinking water approval in accordance with KTW and DVGW worksheet W 270

PE - Polyethylene

for Sika® WESTEC® waterbars

This range is approved for use as joint waterstopping materials in structures and areas designed for the storage, filling and handling of substances hazardous to water (LAU in Germany); plus installations for the production, processing and use of water-pollutant substances (HBV in Germany). This is due to its very high chemical resistance and in particular, the material is resistant to many hydrocarbons (e.g. fuels and solvents). Its elongation at break is approx. 900% and its tensile strength approx. 28 MPa. The waterbars made from it are comparatively hard and therefore their handling and installation varies considerably from the usual waterstop standards.

- Approval/Compliance:
Approval DIBt Z-74,5-121 in accordance with German Water Management Act (WHG) for use in LAU facilities (storage, filling and handling of substances hazardous to water)



Sika® Waterbars

Profiles, shapes and materials

Material		Expansion joint waterbars	Construction joint waterbars	Capping joint waterbars
Elastomer (DIN 7865)	Internal	FM 	F 	FAE FFK
		FM... HS 		
		FMS 	FS 	
		FMS... HS 		
	External	AM 	A 	
Tricomer® (DIN 18541)	Internal	D 	A 	FA
			A... FIX 	
		D... TS 	A... TS 	
	External	DA 	AA 	
		DA... angle Angle, external (A) Angle, either way (W) 	AA... angle Angle, external (A) Angle, either way (W) 	

Sika® Waterbars

Design specifications according to DIN 18197

General information

1. Joint width

The design diagrams apply to an initial/nominal joint width w_{nom} for the internal expansion joint and the joint capping waterbars of 20 – 30 mm and 20 mm for the external expansion joint waterbars.

2. Position in the component

Cover depth rule:
Embedment depth $t \leq$ cover depth \bar{u}

Simplified cover depth rule (DIN 18197):
Component thickness $d \geq$ total waterbar width a

3. Minimum component thickness for internal waterbars

The component thickness around the waterbar must be at least equal to the waterbar width. A component thickness of 30 cm is adequate for the D 320 waterbar.

4. Design (water pressure and movement)

4.1 The diagrams below apply to waterbars according to DIN 18541 and DIN 7865. The various profiles may also be suitable for higher stress – as individually assessed.

4.2 The dimensional information in the general appraisal certificate abP applies to PVC-P waterbars.

Design water level: The maximum expected groundwater, interlayer water or flood water; for tanks, the filling level.

DIN 18197 covers the planning principles, installation, jointing and design of the waterbars, allowing for all the principles defined in that DIN.

Waterbar	Shape/type	Joint width w_{nom}
	FM, FMS, DA	20 – 30 mm
	FAE, FA	20 – 30 mm
	AM, DA	20 mm

Cover depth rule

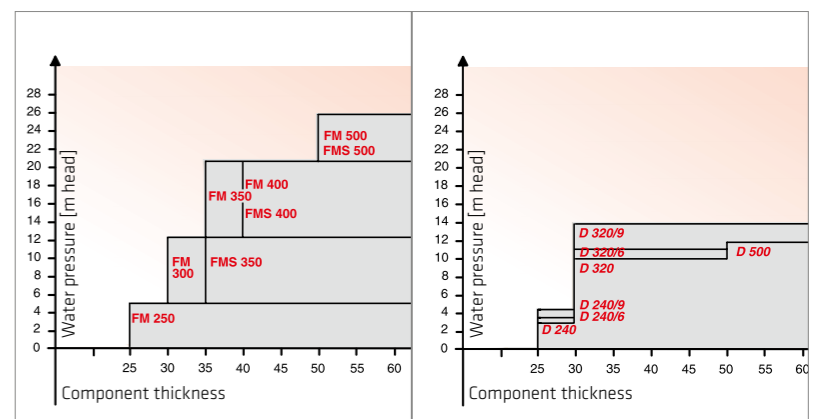
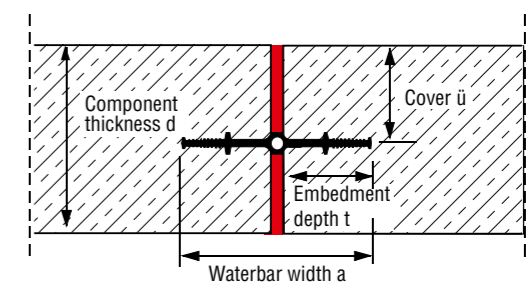

Resulting movement v_r :

v_r = resulting movement,
 v_x = movement in x axis,
 v_y = movement in y axis,
 v_z = movement in z axis

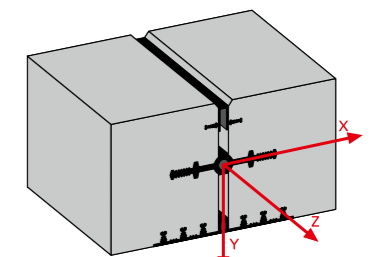

$$v_r = \sqrt{v_x^2 + v_y^2 + v_z^2}$$

Sika® Tricomer® Waterbars acc. to DIN 18541

Calculation diagram acc. to DIN 18197

D
Internal expansion joint waterbars

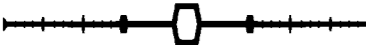

For each additional millimetre of waterbars thickness, the allowable water pressure increases by 10%, maximum of 50%. See DIN 18197

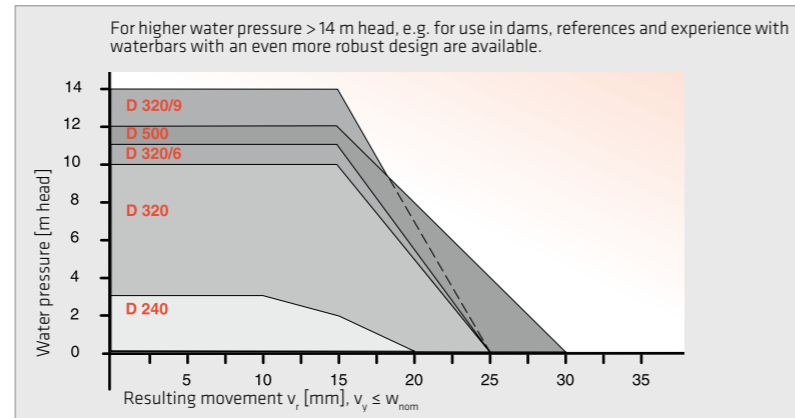

DA
External expansion joint waterbars

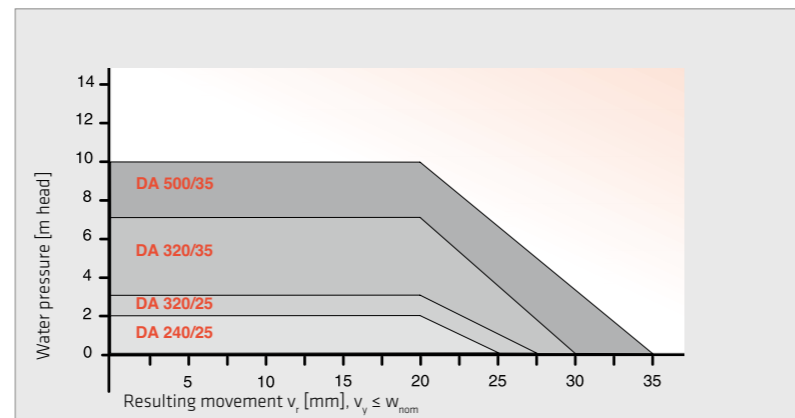
FA
Capping joint waterbar

A
Internal construction joint waterbars

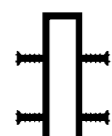
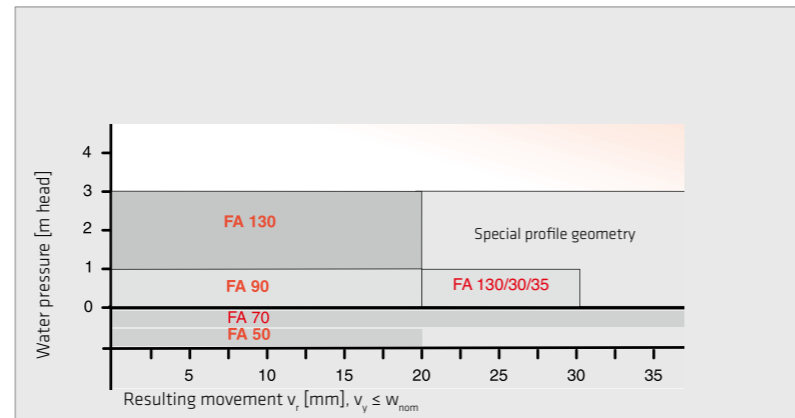

AA
External construction joint waterbars



Construction joint waterbars Classification						
Expansion joint waterstops	Component thickness mm	Construction joint waterstops				
D 240	≥ 250	A 240				
D 320	≥ 300	A 320				
D 500	≥ 500	A 500				
D 250/6~/9	≥ 250	A 240				
D 320/6~/9	≥ 300	A 320				
DA 240	*	AA 240				
DA 320	*	AA 320				
DA 500	*	AA 500				

* Free choice

Sika® Elastomer Waterbars acc. to DIN 7865

Calculation diagram acc. to DIN 18197

FM
Internal expansion joint waterbars

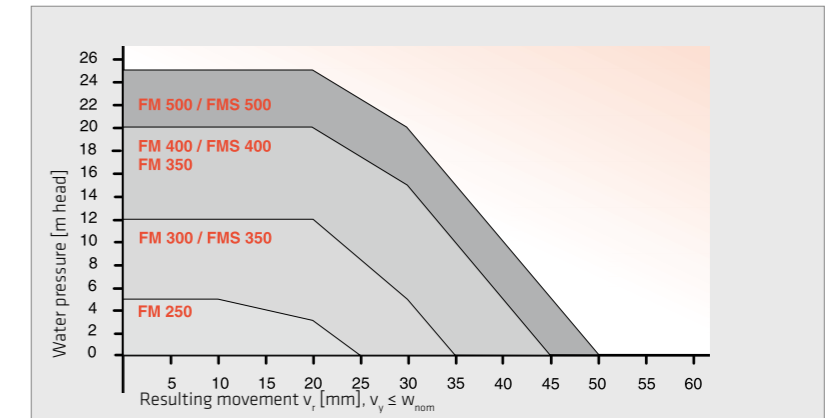

FMS
Internal expansion joint waterbars with lateral steel plates

AM
External expansion joint waterbars

FAE und FFK
Capping joint waterbars

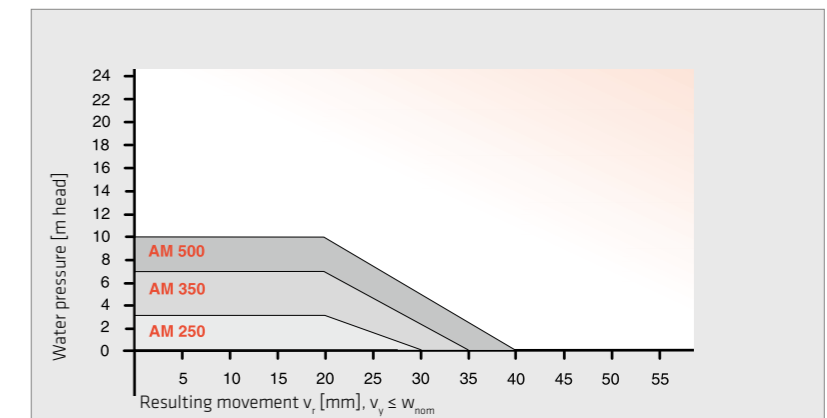
F
Internal construction joint waterbars

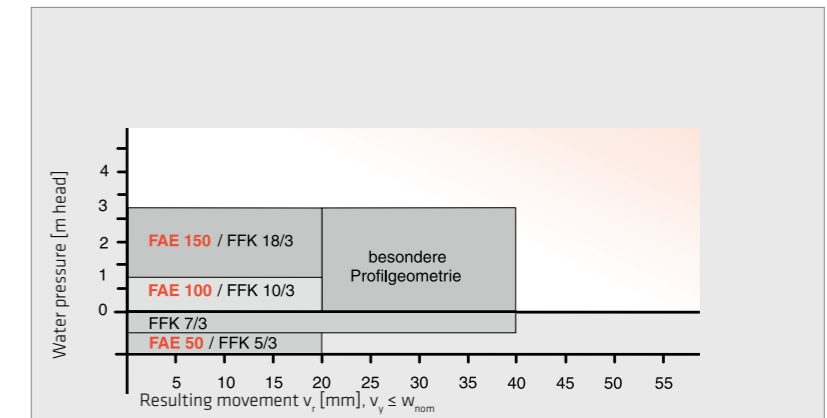

FS
Internal construction joint waterbars with lateral steel plates



A
External construction joint waterbars



Expansion joint Waterbars Classification						
Expansion joint waterstops	Component thickness mm	Construction joint waterstops				
FM 250	250	F 200				
FM 300	300	F 200				
FM 350	350	F 250				
FM 400	400	F 250				
FM 500	500	F 300				
FMS 350	350	FS 310				
FMS 400	400	FS 310				
FMS 500	500	FS 310				
AM 250	*	A 250				
AM 350	*	A 350				
AM 500	*	A 500				

* frei wählbar

Sika® PVC-P Waterbars For Expansion Joints

Acc. to Sika in-house standards with abP Approval

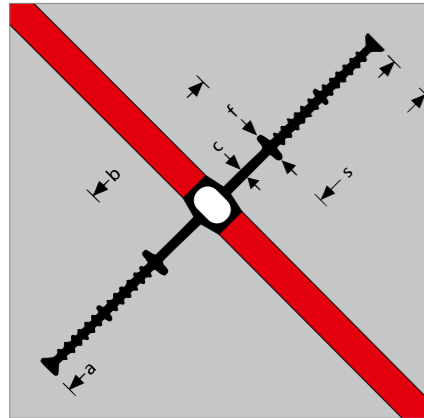

Sika® PVC-P In-house standards	Total width a	Width of expansion part b	Thickness of expansion part c	Width of sealing part s	Height of anchoring ribs f
D 24	240	85	4	78	15
D 32	320	110	5	105	15
Reinforced expansion joint waterbars with fixing loop					
SFD 32	320	100	4,5	110	15

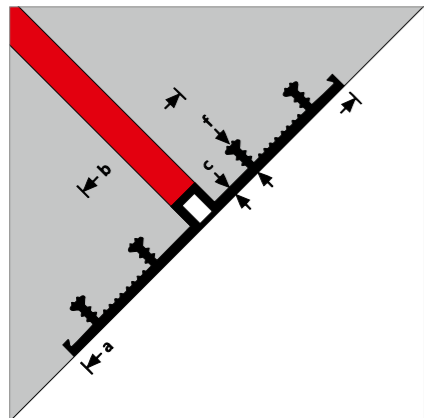

Sika® PVC-P In-house standard	Total width a	Width of expansion part b	Thickness c	Profile height f	Number anchoring ribs N
DF 24	240	90	4	20	4
DF 32	330	104	4	20	6
DF 50	500	124	4	20	8

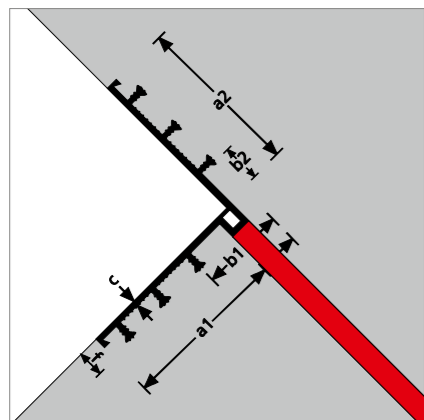

Sika® PVC-P In-house standard	Total width a1/a2	Width of expansion part b1/b2	Thickness c	Profile height f	Number anchoring ribs N
DF 32 edge A	176/156	63/43	4	20	6
DF 32 edge W	176/156	63/43	4	20	6

A = Anchoring ribs external, W = Anchoring ribs either way

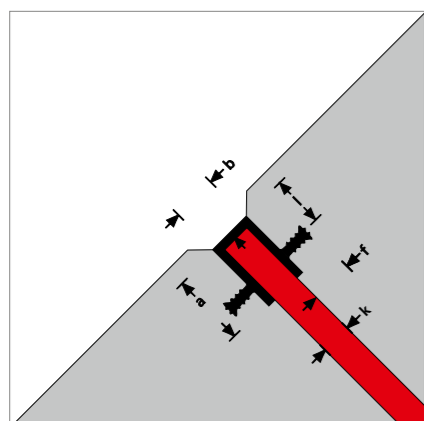

Sika® PVC-P In-house standard	Total width a	Loop height l	Exposed width b	Joint width k	Profile height f	Number anchoring ribs N
FF 5/3	50	35	30	20	25	2
FF 10/3	95	35	30	20	25	4

Sika® PVC-P Waterbars For Construction Joints

Acc. to Sika in-house standards with abP Approval

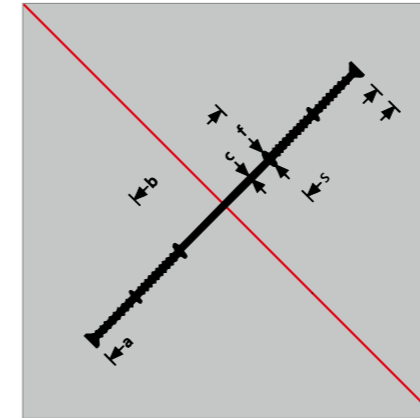

Sika® PVC-P In-house standards	Total width a	Width of expansion part b	Thickness of expansion part c	Width of sealing part s	Height of anchoring ribs f
A 24	240	85	3,5	77,5	15
A 32	320	110	4,5	105	15
Reinforced construction joint waterbars					
SFA 24	240	70	3,5	85	15
Spring-steel reinforced construction joint waterbars					
ISA/F 24	237	88	4	75	12
ISA/F 32	316	106	4	105	14

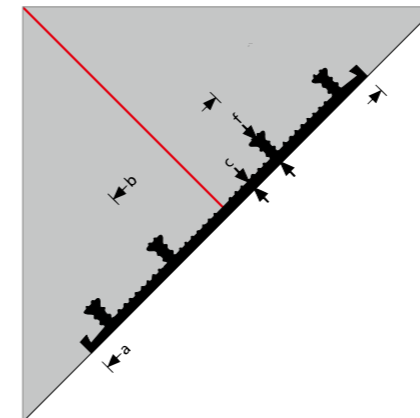

Sika® PVC-P In-house standards	Total width a	Width of expansion part b	Thickness c	Profile height f	Number anchoring ribs N
AF 24	240	90	4	20	4
AF 32	330	104	4	20	6

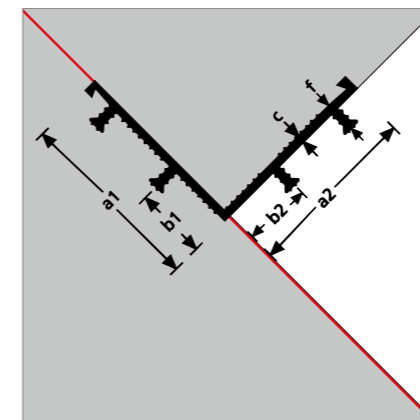

Sika® PVC-P In-house standards	Total width a1/a2	Width of expansion part b1/b2	Thickness c	Profile height f	Number anchoring ribs N
AF 32 edge A	165/165	52/52	4	20	6
AF 32 edge W	165/165	52/52	4	20	6

A = Anchoring ribs external, W = Anchoring ribs either way

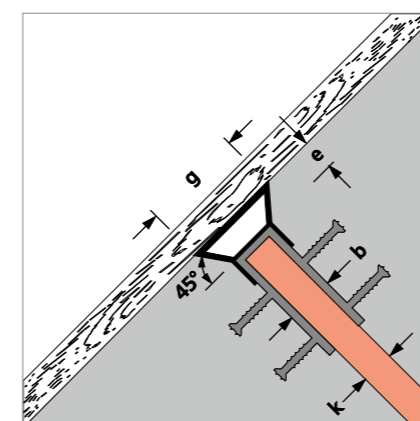

Installation aids For capping joint waterbars	Joint width k	Exposed width b	Chamfer height e	Width of trapezoidal strip g	Length L
TFL 20	10	20	15	50	1000
TFL 30	20	30	15	60	1000
TFL 40	30	40	15	70	1000
TFL 50	40	50	15	80	1000

■ The installation aid is coordinated with the exposed width of the capping joint waterbars.

Sika® Tricomer® Waterbars For Expansion Joints

Acc. to DIN 18541

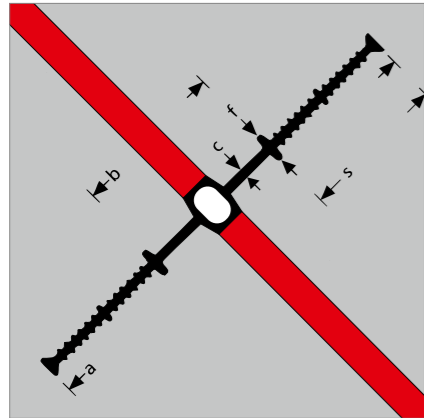

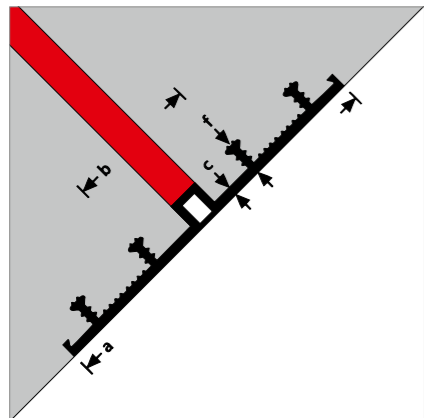

Sika® Tricomer® DIN 18541	Total width a	Width of expansion part b	Thickness of expansion part c	Width of sealing part s	Height of anchoring ribs f	
D 240	240	85	4,5	78	15	
D 320	320	110	5,5	105	15	
D 500	500	155	6,5	173	20	
D 250/6	250	120	6	65	25	
D 320/6	320	170	6	75	25	
D 250/9	250	120	9	65	25	
D 320/9	320	120	9	100	25	
Very robustly profiled and dimensioned expansion joint waterbars						
D 260/9 TS	260	125	9*	68	24	*on the central hose
D 400/11 TS	400	195	11*	103	29	

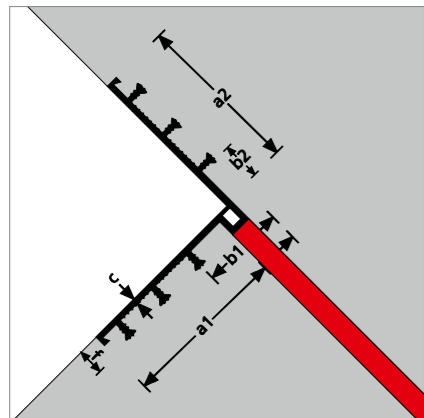

Sika® Tricomer® DIN 18541	Total width a	Width of expansion part b	Thickness c	Profile height f	Number anchoring ribs N
DA 240/25	240	90	4,5	25	4
DA 240/35	240	104	5	35	4
DA 320/25	330	104	4,5	25	6
DA 320/35	330	104	5	35	6
DA 500/35	500	124	5	35	8



Sika® Tricomer® DIN 18541 part 2	Total width a1/a2	Width of expansion part b1/b2	Thickness c	Profile height f	Number anchoring ribs N
DA 240 edge A	130/111	55/36	4,5	20	4
DA 240 edge W	130/111	55/36	4,5	20	4
DA 320 edge A	176/156	63/43	4,5	20	6
DA 320 edge W	176/156	63/43	4,5	20	6

 A = Anchoring ribs external, W = Anchoring ribs either side

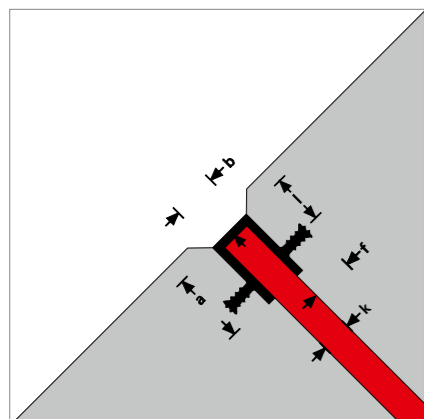

Sika® Tricomer® DIN 18541	Total width a	Loop height l	Exposed width b	Joint width k	Profile height f	Number anchoring ribs N
FA 50/20/25	50	35	30	20	25	2
FA 50/20/35	50	35	30	20	35	2
FA 70/20/45	70	50	30	20	45	2
FA 90/20/25	95	35	30	20	25	4
FA 90/20/35	95	35	30	20	35	4
FA 130/30/35 **	140	40	40	30	35	4
FA 130/50/35 **	140	40	60	50	35	4
FA 130/20/25	140	35	30	20	25	6
FA 130/20/35	140	35	30	20	35	6

** DIN 18541 part 2

Sika® Tricomer® Waterbars For Construction Joints

Acc. to DIN 18541

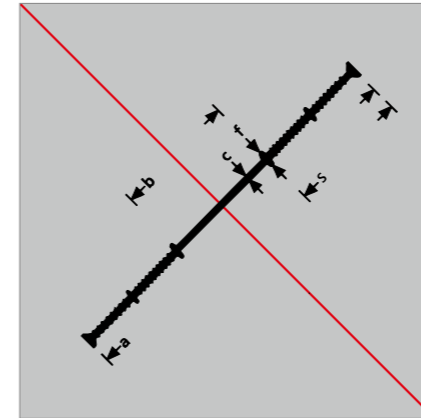

Sika® Tricomer® DIN 18541	Total width a	Width of expansion part b	Thickness of expansion part c	Width of sealing part s	Height of anchoring ribs f
A 240	240	85	4	77,5	15
A 320	320	110	5	105	15
Very robustly profiled and dimensioned construction joint waterbars					
A 320/10 TS	320	190	10	77,5	26

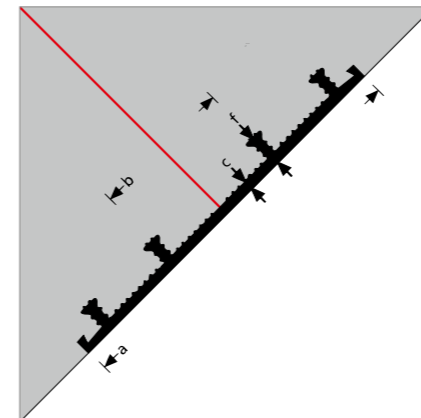

Sika® Tricomer® DIN 18541	Total width a	Width of expansion part b	Thickness c	Profile height f	Number anchoring ribs N
AA 240/25	240	90	4,5	25	4
AA 240/35	240	104	5	35	4
AA 320/25	330	104	4,5	25	6
AA 320/35	330	104	5	35	6
AA 500/35	500	124	5	35	8

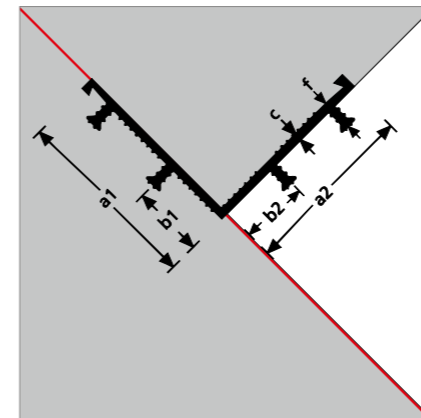

Sika® Tricomer® DIN 18541 part 2	Total width a1/a2	Width of expansion part b1/b2	Thickness c	Profile height f	Number anchoring ribs N
AA 240 edge A	120/120	45/45	4,5	20	4
AA 320 edge A	165/165	52/52	4,5	20	6



 A = Anchoring ribs external, W = Anchoring ribs either side



Welding of thermoplastic Sika® Waterbars

Formpiece connections of thermoplastic Sika® Waterbars like edges, crosses and T-pieces are made in the factory. Only longitudinal butt joint connections are made on site. The welding equipment used must enable simultaneous heating, melting and jointing to be carried out across the whole area of the connection. The profile ends must be compressed immediately after heating/melting at an evenly applied jointing pressure. Any joints formed on site must be made only by the waterbar manufacturer's technical personnel or by jointing technicians specifically trained by the manufacturer.

Sika® Elastomer Waterbars For Expansion Joints

Acc. to DIN 7865

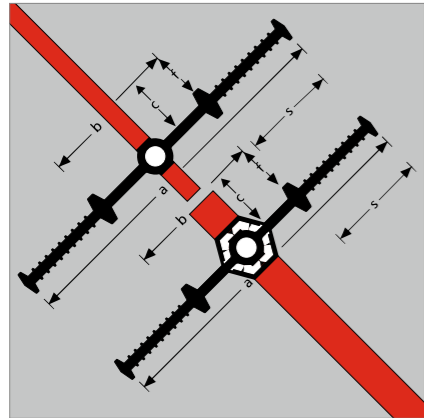

Sika® Elastomer DIN 7865	Total width	Width of expansion part	Thickness of expansion part	Width of sealing part	Height of anchoring ribs
	a	b	c	s	f
FM 200	200	110	9	45	32
FM 250	250	125	9	63	32
FM 300	300	175	10	63	32
FM 350	350	180	12	85	38
FM 400	400	230	12	85	38
FM 500	500	300	13	100	38
Expansion joint waterbar with encased centre bulb					
FM 350 HS	350	180	12	85	38

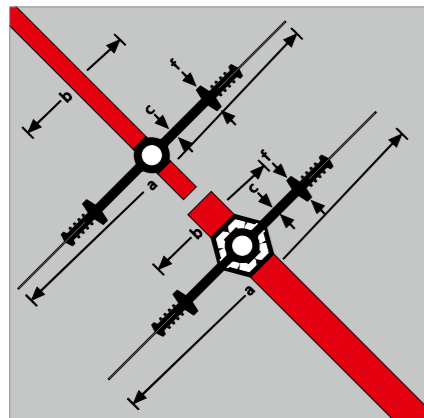

Sika® Elastomer DIN 7865	Total width	Width of expansion part	Thickness of expansion part	Width of sealing part*	Height of anchoring ribs
	a	b	c	s	f
Expansion joint waterbar with lateral steel plates					
FMS 350	350	120	10	45	32
FMS 400	400	170	11	45	32
FMS 500	500	230	12	65	38
Expansion joint waterbar with lateral steel plates and central hose sheeting					
FMS 400 HS	400	170	11	45	32
FMS 500 HS	500	230	12	65	38
<p>■ The FMS ...HS profile range is most suitable for wide joints and joints which do not allow expansion, or for standard expansion joints if large settlement movement is expected.</p> <p>* Excluding steel plate</p>					

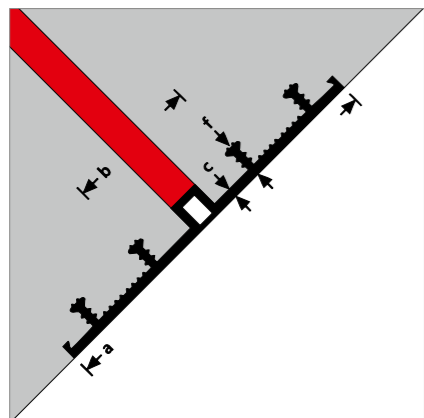

Sika® Elastomer DIN 7865	Total width	Width of expansion part	Thickness	Profile height	Number anchoring ribs
	a	b	c	f	N
AM 250	250	100	6	31	4
AM 350	350	100	6	31	6
AM 500	500	150	6	31	8

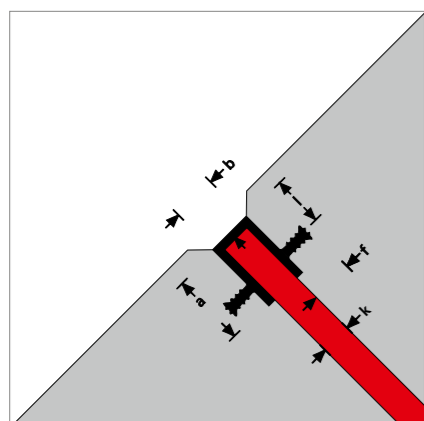

Sika® Elastomer DIN 7865: Type FAE DIN 7865 part 2: Type FFK	Total width	Loop height	Exosed width	Joint width	Profile height	Number anchoring ribs
	a	l	b	k	f	N
FAE 50	55	35	30	20	30	2
FAE 100	105	35	30	20	30	4
FAE 150	155	35	30	20	30	6
FFK 5/2	55	35	20	10	35	2
FFK 7/3	70	50	30	20	45	2
FFK 7/4	70	50	40	30	45	2
FFK 7/5	70	50	50	40	45	2
FFK 10/3	100	35	30	20	45	4
FFK 18/3	180	55	30	20	30	6

Sika® Elastomer Waterbars For Construction Joints

Acc. to DIN 7865

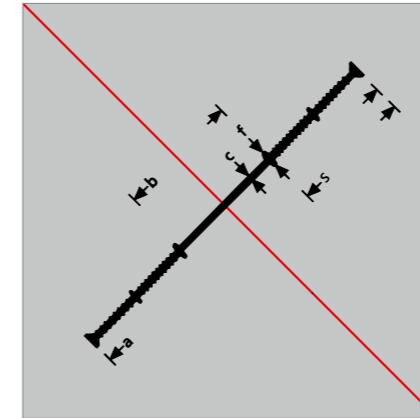

Sika® Elastomer DIN 7865	Total width	Width of expansion part	Thickness of expansion part	Width of sealing part	Height of anchoring rib
	a	b	c	s	f
F 200	200	75	7	62,5	26
F 250	250	80	8	85	26
F 300	300	100	8	100	26

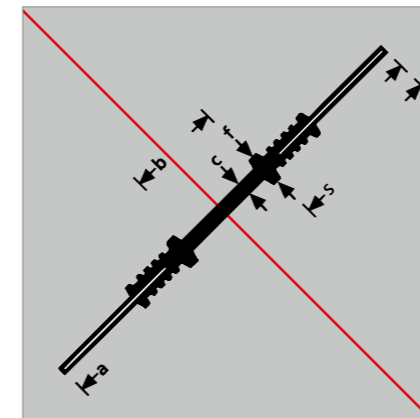

Sika® Elastomer DIN 7865	Total width	Width of expansion part	Thickness of expansion part	Width of sealing part	Height of anchoring rib
	a	b	c	s	f
Construction joint waterbars with lateral steel plates					
FS 270	270	60	7	105	22
FS 310	310	80	8	115	22

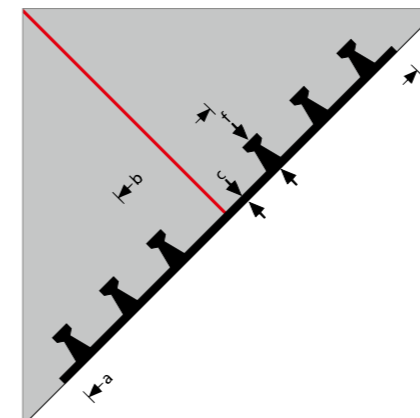

Sika® Elastomer DIN 7865	Total width	Width of expansion part	Thickness	Profile height	Number Anchoring ribs
	a	b	c	f	N
A 250	250	100	6	31	4
A 350	350	100	6	31	6
A 500	500	150	6	31	8



Sika® Waterbars Elastomer vulcanization	
<p>Formpiece connections of Sika® Waterbars Elastomer like edges, crosses and T-pieces are made in the factory. The Sika® Waterbars Elastomer Type are butt jointed together by vulcanization on site, i.e. with added rubber strips and the action of heat and pressure in a vulcanizing equipment with moulds dependent on the waterbar profile used and longitudinal strain and specified vulcanizing parameters for the specific forms (temperature and time). Site joints must be done only by trained and qualified personnel.</p>	

Sika® WESTEC® waterbars

Uses

Waterbars for Ground Water Protection areas in Germany must be approved by the Deutsche Institut für Bautechnik (DIBt) and provide outstanding chemical resistance. They can then be used for the waterproofing of expansion and construction joints in structures for the:

- Storage, handling and filling of substances hazardous to water (LAU facilities in Germany)
- Production, handling and use of substances hazardous to water (HBV facilities in Germany)
- Biodiesel production, filling and storage facilities

Chemical resistance

Classification of substances under DIBt Guidelines for chemical resistance		Sika® WESTEC® waterbars
1.	Diesel fuel, super and normal (according to EN 228: 2004-03) with max. 5% by vol. bio-alcohol	high
2.	Aviation fuel	high
3.	<ul style="list-style-type: none"> ■ Domestic fuel oil ■ Unused vehicle engine oil ■ Unused vehicle gear oil ■ Mixtures of saturated and aromatic hydrocarbons with an aromatic content of ≤ 20% by wt. and flash point > 55oC 	high
3a.	Diesel fuel (according to EN 590: 2004-03) with max. 5% by vol. biodiesel	high
4.	All hydrocarbons	high
4a.	Benzene and mixtures containing benzene	high
4b.	Crude oil	high
4c.	Used vehicle engine and gear oil with flash point > 55oC	high
5.	Monohydric and multihydric alcohols (up to 48% methanol by vol. max.), glycol ethers	high
5a.	All alcohols and glycol ethers (including 5 and 5b)	high
5b.	Monohydric and multihydric alcohols ≥ C 2	high
5c.	Ethanol including ethanol according to DIN EN 15376 (independent of the manufacturing process) as well as their watery solutions	high
6.	All aliphatic halogenated hydrocarbons ≥ C 2	high
6b.	Aromatic halogenated hydrocarbons	high
7.	All organic esters and ketones	high
7a.	Aromatic esters and ketones	high
8.	Aqueous solutions of aliphatic aldehydes	high
9a.	Organic acids (carboxylic acids, except formic acid), and their salts (in aqueous solution)	high
10.	Mineral acids up to 20% and acidic hydrolysing inorganic salts in aqueous solution (pH < 6), except hydrofluoric acid and oxidizing acids and their salts	high
11.	Inorganic lyes and alkaline hydrolysing inorganic salts in aqueous solution (pH > 8), except ammonia solutions and oxidizing solutions of salts (e.g. hypochlorite)	high
12.	Aqueous solutions of inorganic, non-oxidizing salts with a pH value between 6 and 8	high
13.	Amines and their salts (in aqueous solution)	high
14.	Aqueous solutions of organic surfactants	high
---	Single fluids: <ul style="list-style-type: none"> ■ BA heavy boilers (Butyl Heavy Ends) ■ Ethylene glycol ■ Phenylsilanes ■ N-methylpyrrolidin-2-one (NMP) ■ Green oil according to the specification of BSL Olefinverbund GmbH Böhlen ■ Pyrolysis gasoline ■ styrene (stabilized) ■ Dowtherm Q-E Heat Transfer Fluid 	

When planning, installing and using these approved joint tape systems, the specifications of general building approval Z-74.5-121 and the processing guidelines must be observed.

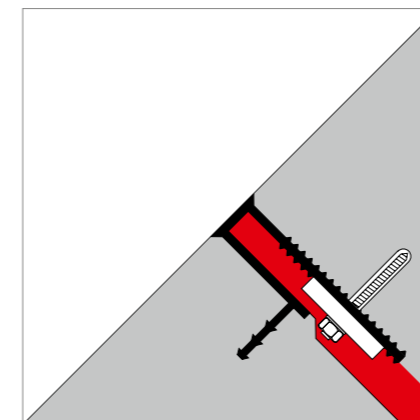
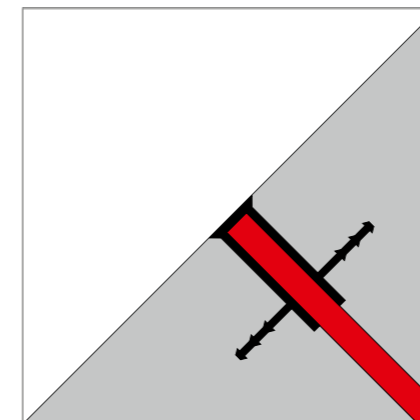
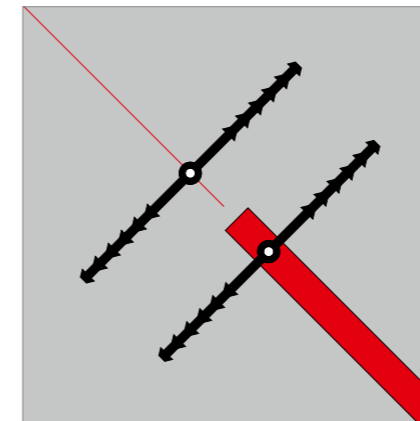

Internal sealing	Total width a	Width of expansion part b	Thickness of expansion part c	Width of sealing part s	Thickness of centre bulb k
Polyethylene PE					
Sika® WESTEC® - Type 050	152	51	4,5	51	11
<ul style="list-style-type: none"> ■ Approved for use in LAU facilities (storage, handling and filling of substances hazardous to water) Approval number: DIBt Z-74.5-121 ■ Suitable for movement joints ■ v, up to 3 mm max. ■ To be used and installed by trained and authorized personal only 					

Joint capping	Total width a	Total height l	Exposed width b	Profile thickness c	Joint width k	Anchoring ribs Heig. Num. f N
Polyethylene PE						
Sika® WESTEC® - Type 631	104	76	35	3,2	20	38 2
<ul style="list-style-type: none"> ■ Approved for use in LAU facilities (storage, handling and filling of substances hazardous to water) Approval number: DIBt Z-74.5-121 ■ Trafficable to "Level t1", vehicles with pneumatic tyres ■ Wear class "XM1", medium wear stress by vehicles with pneumatic tyres ■ v, up to 3 mm max. ■ To be used and installed by trained and authorized personal only 						

Joint capping	Total width a	Total height l	Exposed width b	Profile thickness c	Joint width k	Anchoring ribs Höhe Anz. f N
Polyethylene PE						
Type KFB 631 K-PE	66	124	32	3,5	20	39 1
<ul style="list-style-type: none"> ■ Clamping profile and design are suitable for use in LAU facilities ■ Suitability to be determined and use to be approved on individual projects ■ v, up to 3 mm max. ■ To be used and installed by trained and authorized personal only 						

Sika® Special Waterbars In hydraulic structures



Sika® Special Waterbars in hydraulic structures

The joint waterproofing systems in hydraulic structures are generally exposed to high stress due to combinations of high water pressure, large movement and in some cases they are also to open weathering. For this reason suitably large sized Special Sika Tricomer or Elastomer waterbars are normally used for such complex structures. Specific material types and custom waterstop systems may be required for these demanding applications. These can also require specific testing approvals and inspection at all stages of their design, production and installation, meaning there can necessarily be a considerable time lag before their final approval for use.

- Typical uses
- Flood barriers
 - Connecting joints in sewers
 - Locks
 - Dams
 - Floating tunnel segments

Special waterstop solutions geared to the structural and exposure conditions

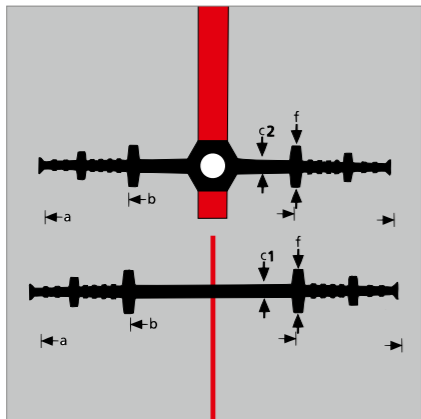

Tricomer®	Total width a	Width of expansion part b	Thickness of expansion part c1/c2	Width of bulb k	Height of anchoring rib f
Sika® Expansion joint waterbar, very robust type					
D 260/9 TS	260	125	9*	20	24
D 400/11 TS	400	195	11*	20	29
Sika® Construction joint waterbar, very robust type					
A 320/10 TS	320	165	10	--	26

- Waterproofing of block joints in dams
- Waterstops of this design with drinking water approval are also available on request

*Thickness in expansion part, measured at the central hose

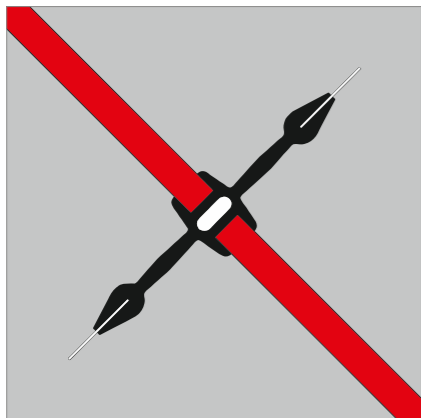

Elastomer	Total width a	Width of expansion part b	Thickness of expansion part c1/c2	Width of bulb k	Height of anchoring rib f
Sika® Expansion joint waterbar with lateral steel plates					
FMS 450 S*	450	186	11/14	32	35

- Materials according to DIN 7865:
SBR Styrene-butadiene rubber (available as standard)
EPDM Ethylene-propylene-diene rubber (available on request by agreement)
- Joint width:
30 mm (standard) for bulb width of 32 mm
Other joint widths (e.g. 40 mm, 50 mm) can be produced
- Uses: e.g. for lamellar joints in locks

* Designation in DIN 7865: FM 450 MD

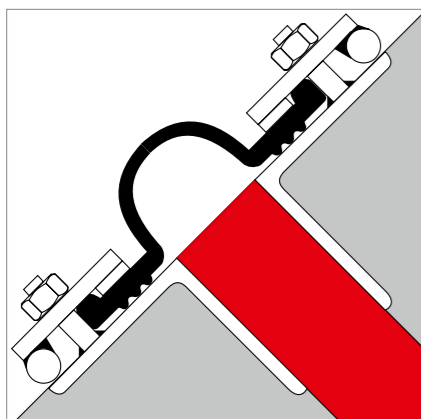

Sika® Elastomer	Total width a	Width of expansion part b	Thickness of expansion part c1/c2	Width of bulb k	Height of anchoring rib f
Sika® Omega profiles for post-waterproofing of joints					
OKB 24	240	130	8	96	68
OKB 30	300	184	8	156	78
OKB 35	350	230	9	200	100
OKB Vario	200 - 1000	Variable	9	Variable	Variable

Sika® Special Waterbars In bridge construction



Sika® Special Waterstops for bridge construction

Detailed specifications for the use of waterbars in bridge construction are given in German Civil Engineering Guidelines ZTV-ING and RIZ-ING, and in German Railways (DB) Guideline 804.6101. For Elastomer waterbars in accordance with DIN 7865, external monitoring must be used for quality control of the joint waterproofing. The longitudinal joint for bascule bridge superstructures is covered around the abutment by a clamped flanged seal with a flat profile as shown in drawing FUG 6. For retractable bridge superstructures the abutment joint is covered by a clamped elastomer apron. Special waterbars are used for joints in bascule superstructures and for waterproofing terminations under the edge capping.

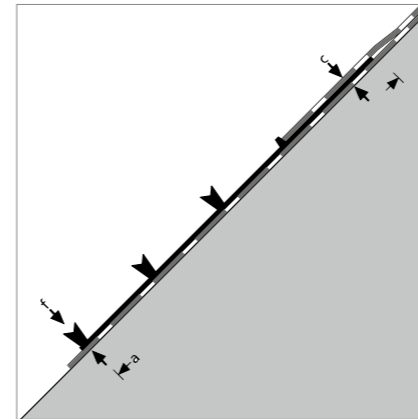

Sika® Elastomer DIN 7865, part 2	Total width a	Thickness c	Profile height f	Number anchoring ribs N
DAB 400	450	4	20	3

- According to DB AG – DS 804.6101 "Railway bridges and other civil engineering structures", figure 1, and the BMV guide ZTV-ING with drawings RIZ-ING
- Waterproofing terminations under the edge capping

Sika® Special Waterbars In tunnel construction

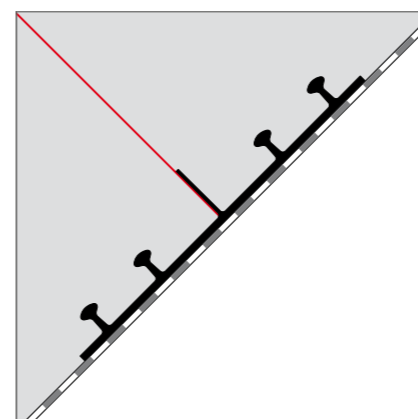

TPO	Total width part a	Width of expansion b	Web thickness c	Profile height f	Number anchoring ribs N
Sika® Waterbar WT AF 130/30	130	-	4	30	3
Sika® Waterbar WT AF 210/30	210	45	4	30	3
Sika® Waterbar WT AF 240/30	240	110	4	30	4
Sika® Waterbar WT AF 310/30	310	110	4	30	4
Sika® Waterbar WT AF 400/30	400	110	4	30	6
Sika® Waterbar WT AF 500/30	500	170	4,5	30	6
Sika® Waterbar WT AF 600/34 Inject*	600	215	4	34	6

- Waterstops in combination with membrane system: there is a full compatibility guaranty through equal material base of waterstop and membrane.

* with injection channels

Sika® Waterbars For Flanging Constructions

For connections, transitions and the waterproofing of existing joints



Sika® Waterbars For Flanging Constructions

For connection joints and post-construction waterproofing of joints

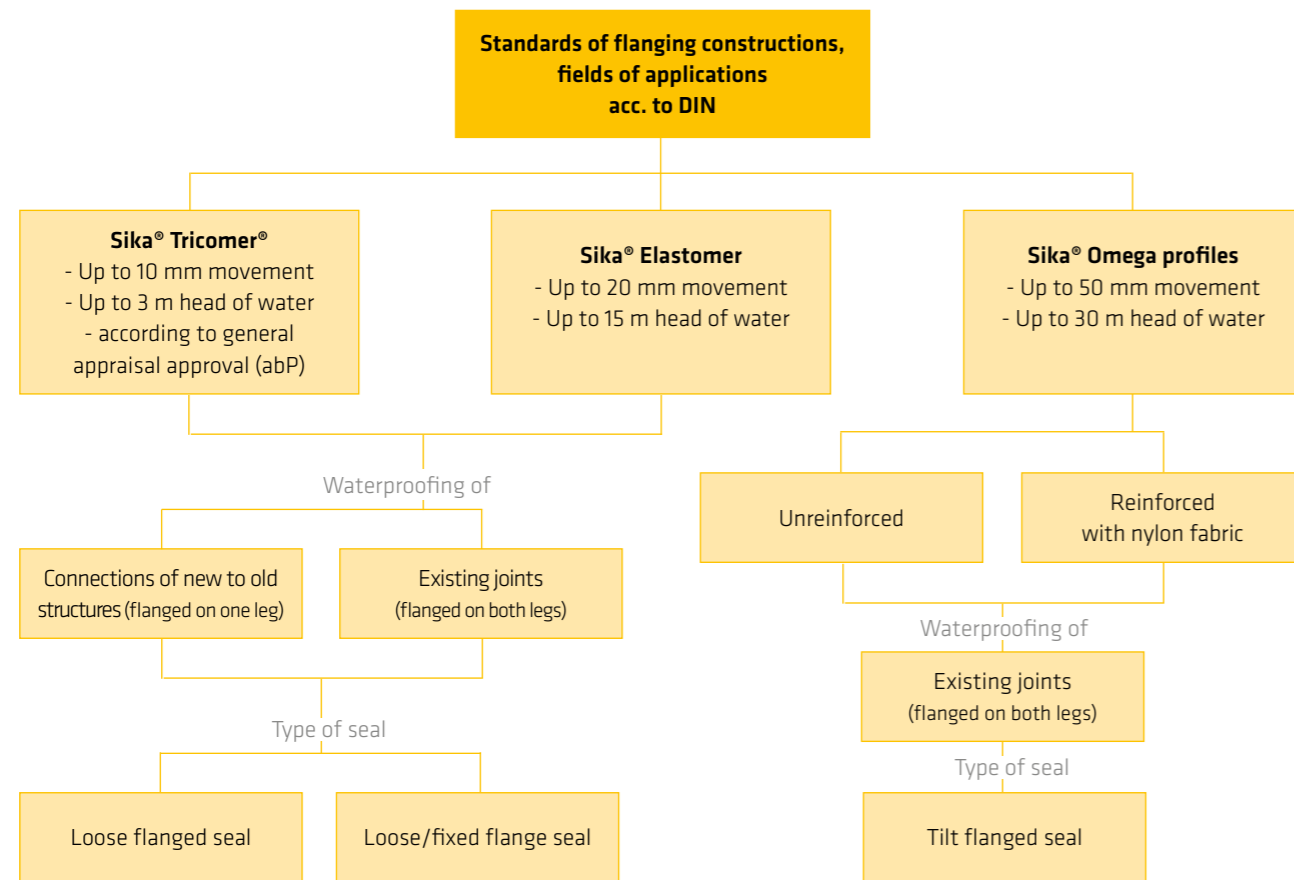

Sika® Waterbars For Flanging Constructions

Characteristics and types

Sika® Tricomer® flanging profiles

- Flanging with Sika® Tricomer® thermoplastic waterbar, DIN 18541-2
- Certification to abP
- Flanging profiles with permanent elasticity and appropriate elastic recovery
- For waterproofing movement and construction joints and joints not allowing expansion, up to a maximum water pressure of 0.3 bar (3 m head) and resulting movement v_r of 10 mm
- Must only be installed by trained and qualified personnel
- Typical uses: connections of new structures to existing, plus waterproofing existing joints

Sika® Elastomer flanging profiles

- Flanging with Sika® Elastomer waterbar, DIN 7865-2
- Robust flanging profiles with high permanent elasticity and elastic recovery
- For waterproofing of movement, construction and connection joints up to a maximum water pressure of 1.5 bar (15 m head) and resulting movement v_r of 20 mm
- Must only be installed by trained and qualified personnel
- Typical uses: connections of new structures to existing; waterproofing of existing joints; transitions / changes in the waterproofing / waterstopping system

Sika® Omega flanging profile

- Flanging with fabric-reinforced Elastomer Omega waterbar
- Robust cross-sections with high permanent elasticity and elastic recovery
- For waterproofing movement joints up to a water pressure of 3.0 bar (30 m head) and more with appropriate design; movement capability dependent on profile and location etc.
- Must only be installed by trained and qualified personnel
- Typical uses: waterproofing movement joints with originally designed and existing Omega fixed flanges, or for joint transitions according to DIN 18195-9

Technical support

For waterproofing and joint waterstop specifications with high demands or special requirements, please contact us for advice – take advantage and benefit from our 30-year experience. Sika provides:

- Design assistance and support
- CAD documentation
- Complete factory-produced waterstop systems

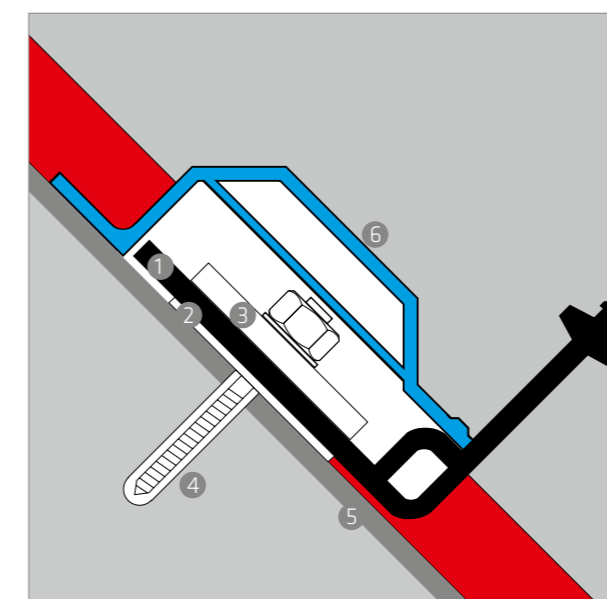

Sika® accessories for loose flanged seals

Standard types, other dimensions on request

- 1 Flanging waterbar
- 2 Raw rubber sealing layer in mm:
50 x 4, 80 x 4, 100 x 4, 120 x 4
- 3 Clamped flange, galvanized V4A in mm:
40 x 6, 80 x 8, 80 x 10, 100 x 10
Hole spacing $e = 15$ cm
(for clamped flange 40 x 6 : $e = 20$ cm)
Clamped flange angles (internal or external angles) 90°
- 4 Galvanized or V4A in mm: 80 x 10, 100 x 10
Chemical anchor galvanized or V4A quality
M 10 x 115 for metal flange 40 x 6
M 12 x 160 for metal flange 80 x 8
M 16 x 190 for metal flange 80 x 10, 100 x 10
- 5 Patching mortars for surface repair and preparation
- 6 Protection profile Sika® KSP 230

Sika® Flanging Profiles

Connections from new to existing structures

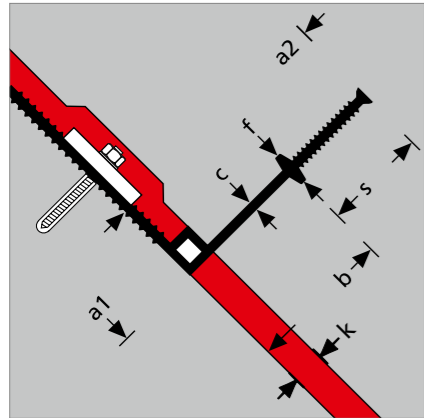

Sika® Tricomer® DIN 18541 part 2	Total width a1/a2	Width of expansion part b	Thickness c	Width of sealing part s	Width of bulb k	Height of anchoring ribs f
D 320 K D 350 K TS	179/170 220/267	95 100	5 11	80 167	22 35	23 28
Sika® Elastomer DIN 7865 part 2						
FM 350 K FM 500 K	190/200 225/272	115 172	10 13	85 100	40 45	38 38

Fixing strip
 Movement cavity

■ KSP protection profile for the movement cavity in the flanged seal

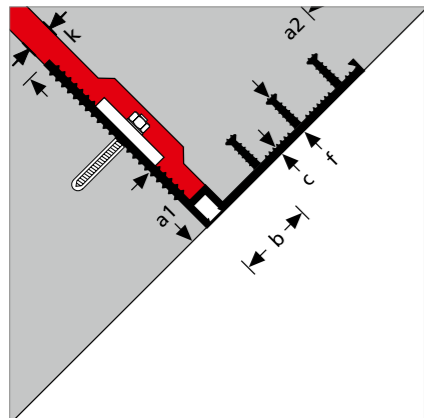

Sika® Tricomer® DIN 18541 part 2	Total width a1/a2	Width of expansion part b	Thickness c	Width of bulb k	Height of anchoring ribs f
DA 320/35 KI DA 320/35 KA	180/204 180/204	88 88	5 5	22 22	35 35
Sika® Elastomer DIN 7865 part 2					
AM 350 K I AM 350 K A	166/211 166/211	86 86	6 6	36 36	31 31

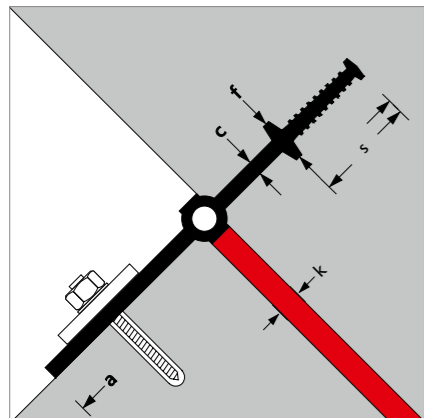

Sika® Elastomer DIN 7865 part 2	Total width a	Thickness c	Width of sealing part s	Width of bulb k	Height of anchoring ribs f
FM 350 KF	350	12	85	20	38

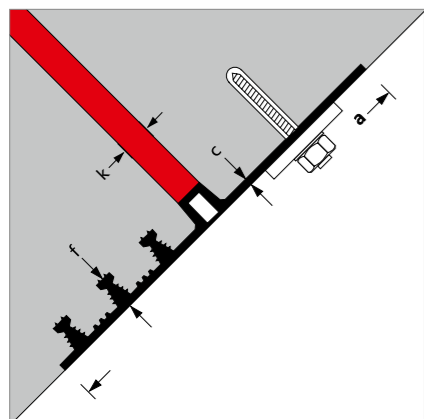

Sika® Tricomer® DIN 18541 part 2	Total width a	Thickness c	Width of bulb k	Height of anchoring rib f
DA 320/35 KF	320	5	20	35
Sika® Elastomer DIN 7865 part 2				
AM 350 KF	350	6	25	31

* Excluding the central hose

Sika® Flanging Profiles

Waterproofing of existing joints

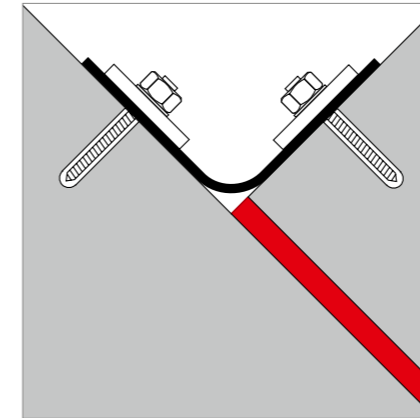

Sika® Tricomer® DIN 18541 part 2	Total width a	Thickness b
FP 300*	300	5
Sika® Elastomer (Fug G)		
FPK 250 FPK 300 FPK 350 FPK 400 FPK 500	250 300 350 400 500	4 4 4 4 4

■ UV and weather resistant elastomer material
* Other widths on request

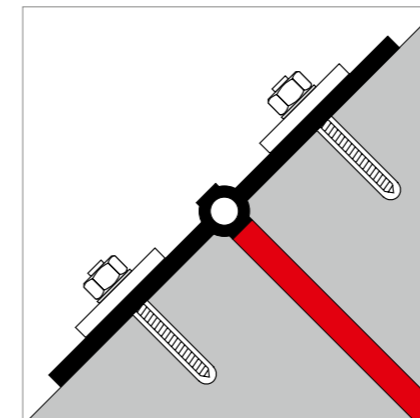

Sika® Tricomer® DIN 18541 part 2	Total width a	Width of expansion part b	Thickness c	Width of loop k	Height of loop f
LF 320*	320	On request	5	20	25
Sika® Elastomer DIN 7865 part 2					
FMG 350*	350	12	20		
Sika® Elastomer DIN 7865 part 2					
AMG 350*	350	On request	6	25	31

* Other widths on request

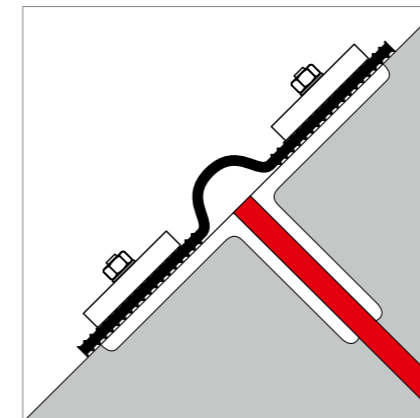

Sika® Tricomer® DIN 18541 part 2	Total width a	Width of expansion part b	Thickness c	Width of loop k	Height of loop f
ZW 360	360	66	7	40	60
Elastomer gewebeverstärkt					
OG 380	380	100	10	80	40
Elastomer nicht gewebeverstärkt					
O 380	380	100	10	80	40

■ Clamping profiles ZW 360, O 380 and OG 380 can be used for loose flange or loose/fixed flange seals.

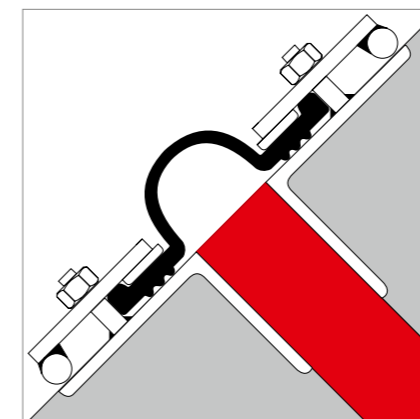

Sika® Omega profiles non fabric reinforced	Total width a	Width of expansion part b	Thickness c	Width of loop k	Height of loop f
OK 24 OK 30	240 300	130 184	8 8	96 156	68 78
Sika® Omega profiles fabric reinforced					
OKB 24 OKB 30 OKB 35	240 300 350	130 184 230	8 8 9	96 156 200	68 78 100

■ Tilt flanged seal, clamped without piercing the profiles.

Sika® KAB Combination System

The dual action system for secure waterproofing

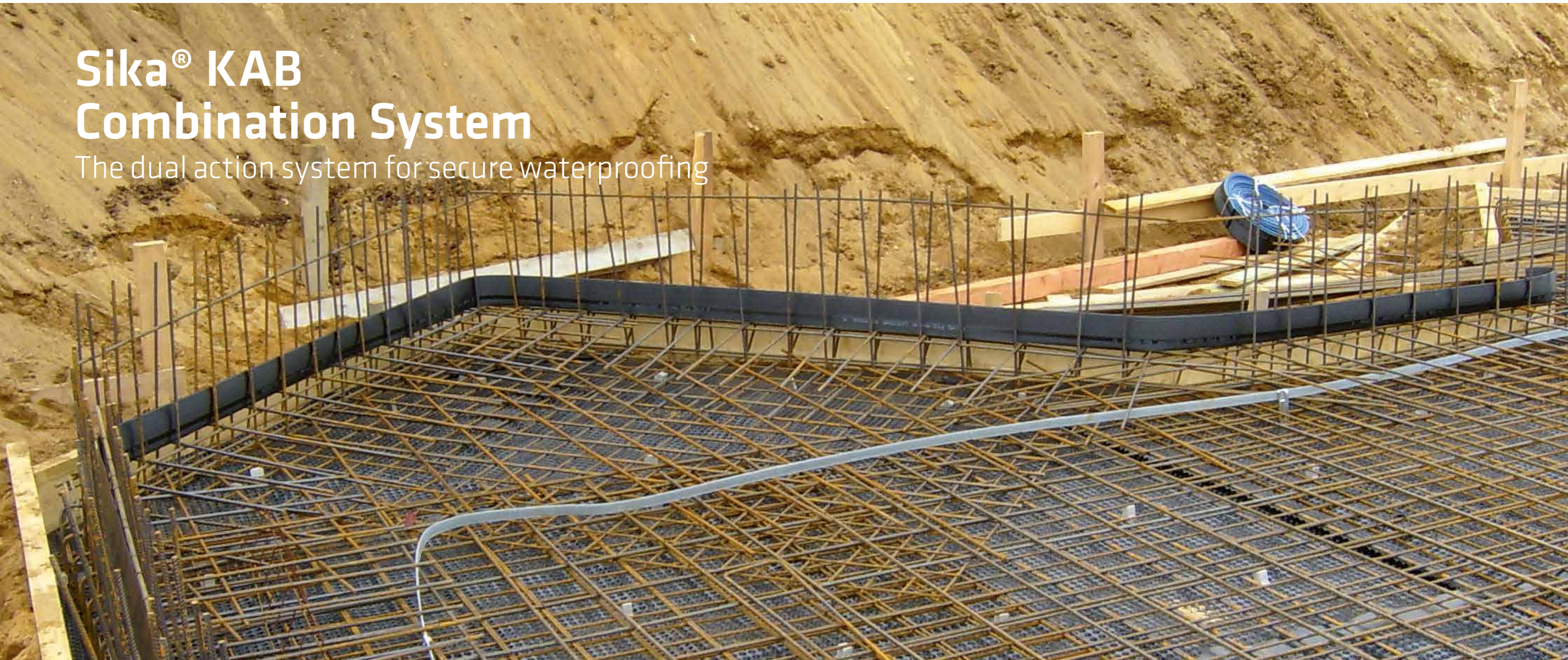

Sika® KAB Combination System

Waterstops with integrated swelling profiles

Sika® KAB combination construction joint waterbars – the dual action system for secure waterproofing of construction and crack induced joints

The two profile types KAB 125 and KAB 150 are designed specifically to suit their individual applications and therefore combine ease of use on site with the highest levels of water-tight protection.

These dual action waterbars that incorporate swelling profiles therefore work with a combination of two sealing principles in one product – the labyrinth principle extending the water path, plus contact pressure sealing. One specific additional advantage is that comparable waterproofing effects can be achieved with much narrower profiles.

The waterstop jointing method is also by welding, or clamping options, plus as they are supplied in longer 25 m rolls, fewer joints are actually required to be made on site. Vertical angles can also be formed easily by simply bending the waterbar and fixing it in position.

Uses

■ Floor/wall construction joints with Sika® KAB 125 and KAB 150
Sika® KAB 125 and KAB 150 waterbars have a swelling profile in the base which is therefore protected from rain on site and it is fixed to the bottom reinforcement with links. There is no need for a break in the reinforcement or a concrete kicker, unlike with traditional waterbars or metal sheet waterstops. The base is cast in by approximately 4 cm and the profiled leg is fully embedded when the wall is concreted.

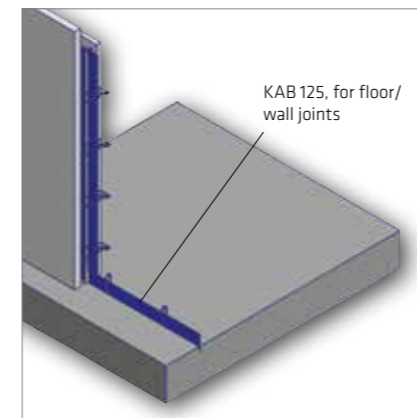
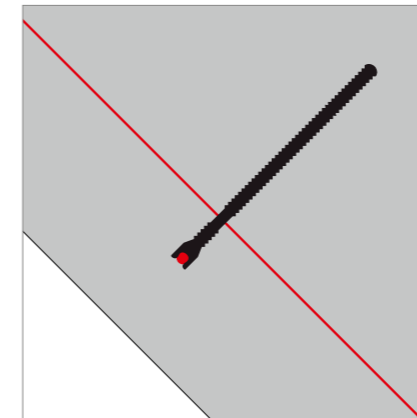
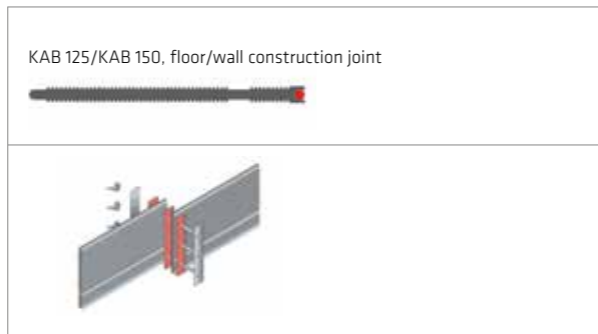

Sika® PVC-P KAB waterbars for floor/wall joints	Total width a	Thickness c	Min. swelling part embed- ment depth t	Swelling of membrane insert wt.-%
KAB 125	125	5	25	> 400
KAB 150	150	5	25	> 400
Clips	Included in the accessories for KAB 125 and KAB 150			
Clamping plates KS	KS 12 for KAB 125 and KS 15 for KAB 150			

■ Sika® KAB accessories:
25 m KAB waterstop with 50 clips in the box (clip spacing approx. 50 cm)

Internal waterproofing of precast basements with the Sika® KAB range

The Sika® KAB waterproofing system was developed partly for precast concrete basements produced according to the German WU guidelines. The KAB construction joint waterbar (KAB) has massive advantages over traditional waterstop systems for this application, because as the waterbar is combined with an integrated swelling membrane, the profiles can be very narrow, which also makes them very suitable for use in filigree structures such as triple walls. Sika® KAB profiles are reinforced and are extremely stable. They provide significant installation and concreting advantages and can be jointed by welding or clamping options.

Sika® Crack Inducing Tubes SR

Waterproofing and cross-section weakening for crack induced joints

Installation information

The crack inducing tube is cut on the underside and pulled over the ISA/F or KAB construction joint waterstop. Clearance from the floor/ceiling concrete approx. 5 cm.

At the top of the wall the crack inducing tube is fixed to the formwork with a shear connector (parallel triangular fillets). The shrinkage crack then passes through and between the triangular fillets on both sides of the concrete walls.

The bottom of the crack inducing tube must be filled during concreting. Complete filling is essential in some types of structure.

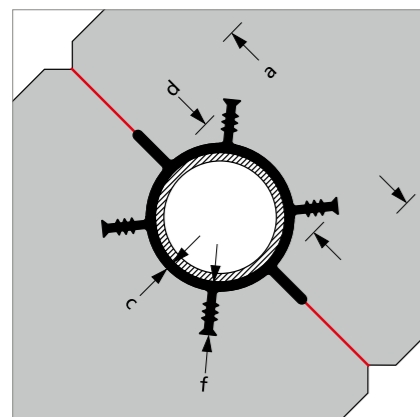
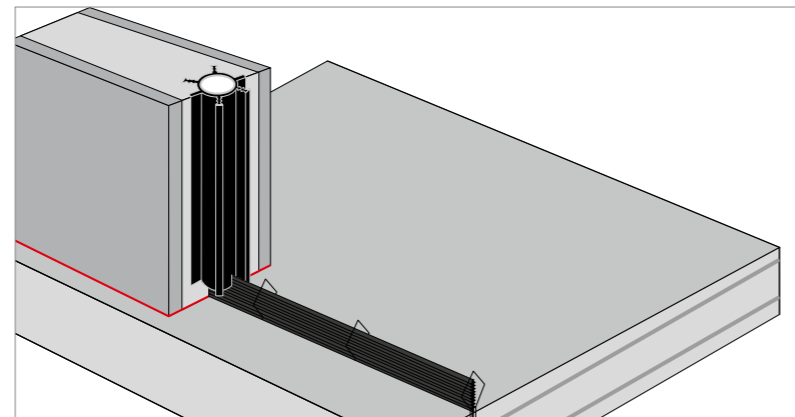
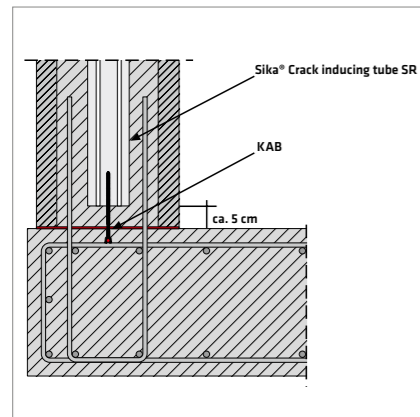

Sika® PVC-P with rigid PVC inner tube	Total width a	Diameter d	Thickness of outer tube c	Height of anchoring ribs f
SR 6	110	64	4	21
SR 9	138	88	4	30
SR 18	235	175	5	35

Standard lengths:

- SR 6: 2.15 m / 2.55 m / 2.75 m / 3.30 m
- SR 9: 2.50 m / 3 m / 4 m
- SR 18: 3 m / 4 m / 5 m
- Non-standard lengths on request

Uses:

- SR 6: For precast section walls and thin site-placed concrete walls
- SR 9: For wall thicknesses from ca. 200 mm to ca. 350 mm
- SR 18: For wall thicknesses from 350 mm to ca. 600 mm

Sika® Metalsheet FBV

Waterproofing by bonding to fresh concrete

Bonding to fresh concrete

This unique technology is based on a coating material which fully bonds with fresh concrete. For both surface and joint waterproofing, this technology provides many options for the reliable and cost effective sealing of concrete structures.

Uses

In joint waterproofing the metal sheets are coated with an FBV membrane and can be used for waterproofing horizontal and vertical construction joints. Its outstanding sealing efficiency has been verified by extensive testing and this is also documented in the German abP Approval Certificate. The Sika® Metalsheet FBV system also has genuine installation advantages.

Advantages

- Weatherproof material
Suitable for use in cold, hot, wet and dry conditions, it is robust and ideal for site works
- Easy to use
No accidental sticking to other surfaces during installation
- Not a dirt trap
Does not absorb dirt when the protective foil is removed
- Secure butt joints
Secure due to the adhesive strength and joint clips
- Lightweight
No heavy materials or high-volume coatings

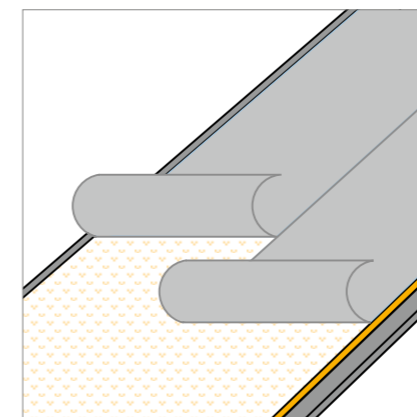

Sika® Metalsheet FBV with special coating	Width mm	Thickness mm	Length m
Sika® Metalsheet FBV 120R roll**	120	1,50	15
Fixing clips 120 PB	Set of 50		
Joint clips	Box of 125 or bag of 100		
Clamping plates KS 12	For connections to expansion joint waterstops		

* 50 in a stable wooden box
** 15 m rolls in cardboard boxes; 36 boxes on pallet (also available as a set with the fixing clips in the box)

Sika® Compression Seals

UV and weather resistant

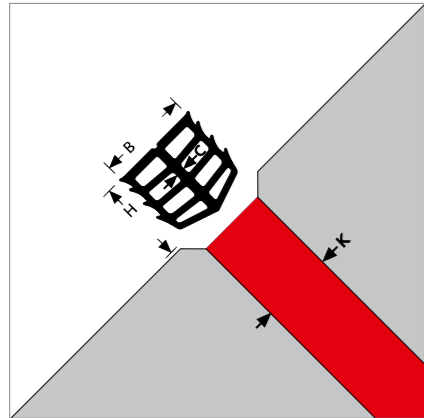

Sika® Tricomer®**/** Grey	Joint width K	Profile width B	Profile height H	Thickness C
KA 22/21	13-17	20	22	2
KA 30/28	20-25	30	30	3
KA 40/40	30-35	40	40	4

Sika® Elastomer Black	Joint width K	Profile width B	Profile height H	Thickness C
MKN 10	8-13	15	22	6
MKN 15	13-20	25	25	2
MKN 20	20-25	31	25	2
MKN 25	25-32	37	30	2
MKN 30	30-38	43	35	3
MKN 40	37-42	52	40	3
MKN 50	43-52	62	50	4
MKN 60	50-60	75	60	4

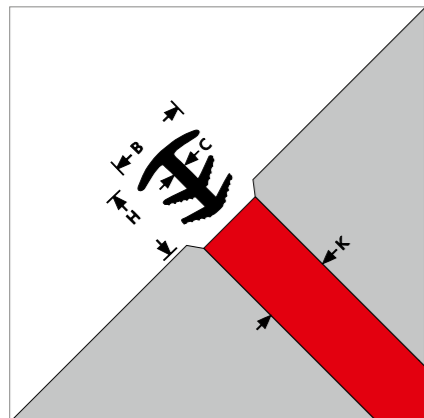

Sika® Elastomer Black	Joint width K	Profile width B	Profile height H	Thickness C
FN 20	15-25	39	38	8
FN 30	25-35	55	40	16
FN 40	35-45	66	43	24

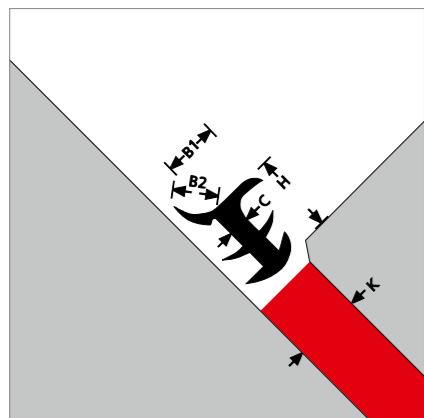

Sika® Elastomer Black	Joint width K	Profile width B1/B2	Profile height H	Thickness C
FN 20 edge	15-25	22/14	45	8
FN 30 edge	25-35	24/24	53	16
FN 40 edge	35-45	35/20	43	24



* Special types and colours on request
 ** Dependent on requirement: Installation with depth stop or side bonding with Sika MK adhesive or SikaSwell-S2
 *** With wide top plate, covers the joint including the chamfers (15 mm each)
 **** Multi-cavity base

Sika® Maro Pipe Waterproofing System

Pipe collars for joint bridging

Functional description

The Sika® Maro pipe collar is manufactured on the basis of the specified outside diameter of the pipe. It is fitted by pressing it over the ends of the pipe and fixing it with the banded clamps. The anchoring ribs are cast in and take over the sealing function on the labyrinth path principle (like external waterstops). The pipe is therefore effectively broken around the expansion joint and this is then bridged and made watertight by the expansion part of the waterstop collar. Variable movement in adjacent components can be absorbed by the expansion part of the collar.

Components /packaging

Waterstop pipe collar:

- 1 Anchoring rib
- 2 Expanding hose
- 3 Banded clamp
- 4 Pipe
- 5 Pipe collar
- 6 Spacer

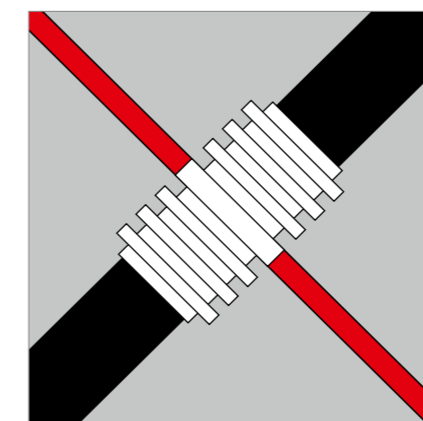
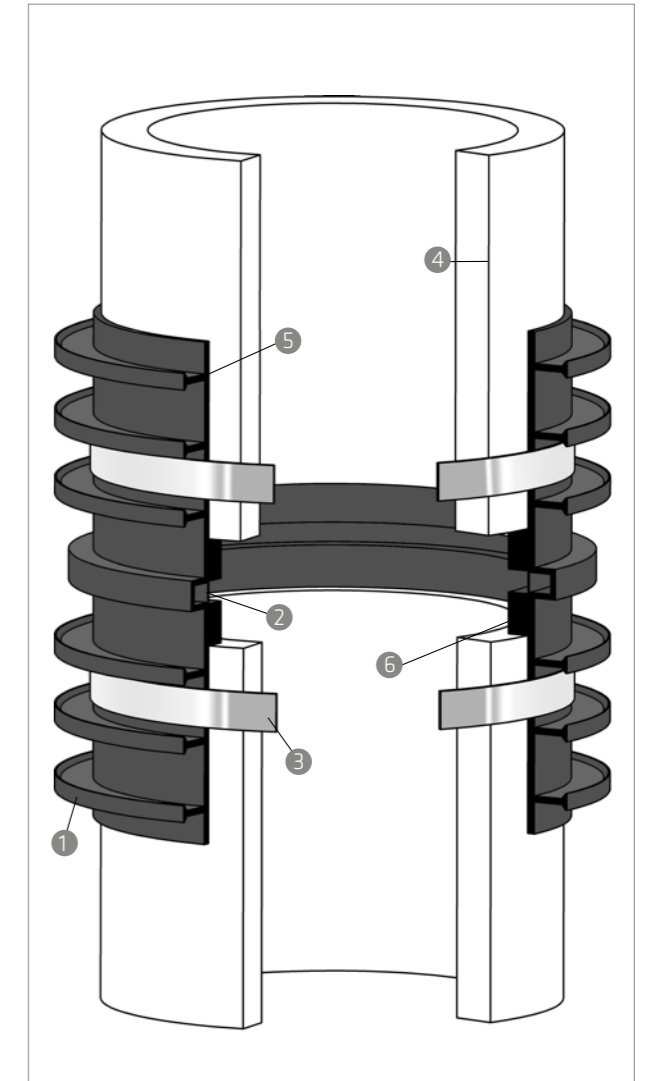

Sika® Tricomer® waterstop pipe collars	Inside Ø up to ...* d	Collar width a	Max. anchoring ribs height f
Typ 200	299	330	20
Typ 300	399	330	20
Typ 400	499	330	35
Typ 500	599	330	35
Typ 600	699	330	35
Typ 700	799	500	35
Typ 800	899	500	35
Typ 900	999	500	35
Typ 1000	1099	500	35

■ Other dimensions from 120 mm on request
 * Design basis for the inside diameter of the collar is the pipe outside diameter

Prefabricated Standard Junctions For Sika® Waterbars



Prefabricated Junctions/Joining Pieces

A wide range of standard prefabricated junction pieces are available for Sika® Waterbars on request.

All have a 50 cm free wing, allowing easy butt-jointing on site. Non standard sections are also available and can be produced, to your engineering drawings giving the exact details and measurements required.

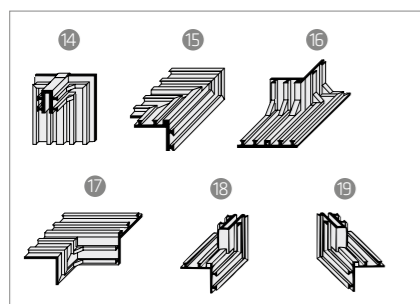
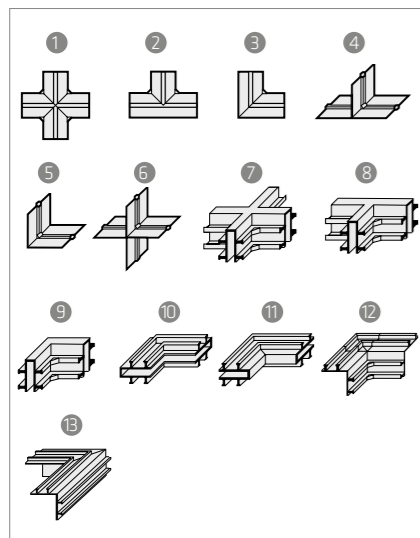

Standard Junctions			
PVC-P and TPO	Available Types:	1 – 13	
Tricomer®	Available Types:	1 – 13	
Elastomer	Available Types:	1 – 11	
	Symmetric corner, type 12 – on request		
	Angle corner, type 13 – on request		
PE	Available Types:	1, 2, 3, 5	
1. flat cross	5. vertical edge	9. vertical edge	13. angle corner
2. flat T	6. vertical cross	10. flat edge external	
3. flat edge	7. vertical cross	11. flat edge internal	
4. vertical T	8. vertical T	12. symmetric corner	

Composite Junctions		
PVC-P and TPO	Available Types:	14 – 19
Tricomer®	Available Types:	14 – 19
Elastomer	on request	
The types shown (14 – 19) are only a selection of the possible composite types		

Prefabricated Waterbar Systems



Waterbar Systems

One of our special services is the manufacture of prefabricated waterbar systems, possibly combining several different profiles and types of junctions according to the specific site waterproofing requirements. Waterbar sections are prefabricated to such an extent, that it is only necessary to weld or vulcanize a few butt joint connections on site. The total length of such custom made system should generally not exceed more than 10 – 20 m, dependent on the type of the profile and the complexity of its installation.

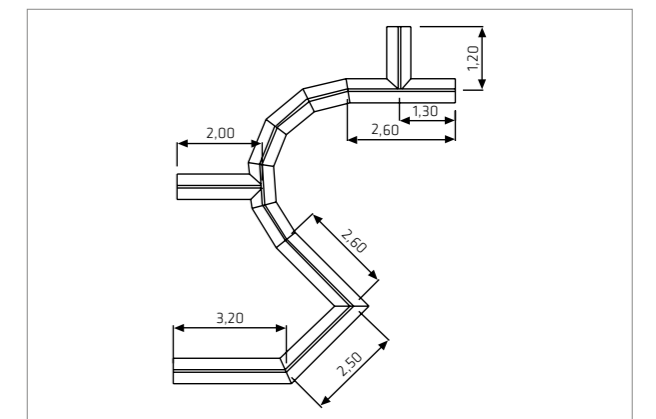
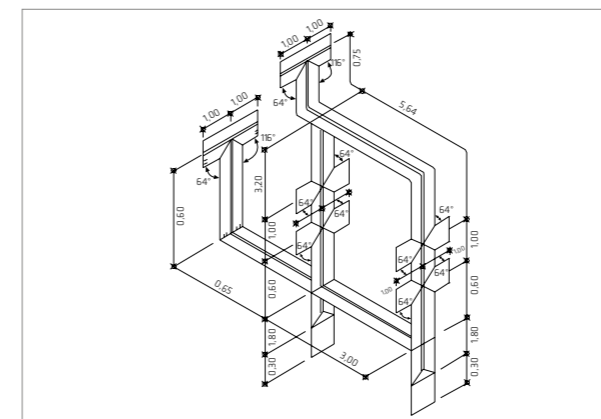
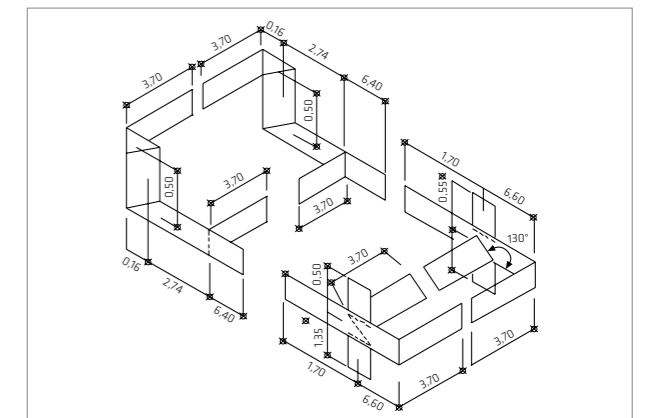
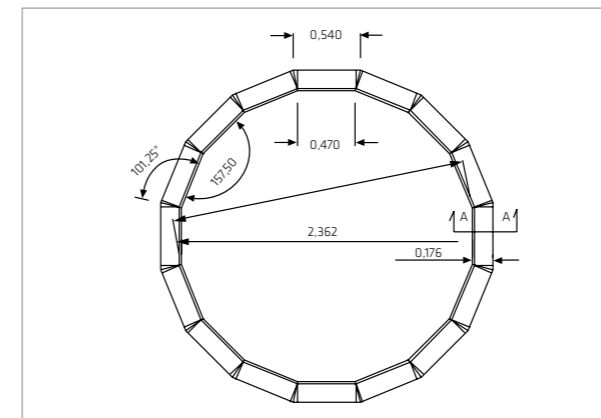

Equipment, Tools And Accessories

For the Welding of Thermoplastic Waterbars



Introduction

Joints between thermoplastic waterbars are made with a heat welding process. This process is reversible. The principle of welding consists of softening the mating surfaces of both of the two parts to be joined by heating them to the melting temperature, quickly pressing them together, and allowing them to cool. Welding is not possible merely by heating and softening one of the two pieces to be welded together. Although the welding of thermoplastic materials is easier and cheaper on site than the vulcanising of Elastomers (artificial rubber based materials), it demands more manual skill and dexterity, as well as ensuring good workmanship and quality control .



Welding Equipment for Sika® Waterbars

Semi-Automatic Tools
Welding equipment type SG 320 L Semi automatic Welding equipment with clamping moulds, dependant on profiles
Tools for Hand Welding
Axe-shaped welding tool 200 W Welding tip 50 W Welding tongue 125 W Hot air blower: - round nozzle, short - round nozzle, long - flat nozzle - quick welding nozzle, round
Welding Accessories
Welding foil Welding strip
Tools
Special knife Special tongue for waterstop clips
Accessories for Installation
Waterbar clip type 1 Waterbar round clip Clip for Sika® Waterbar Clamping Plates - KS 12 - KS 15 - KS 24 - KS 32

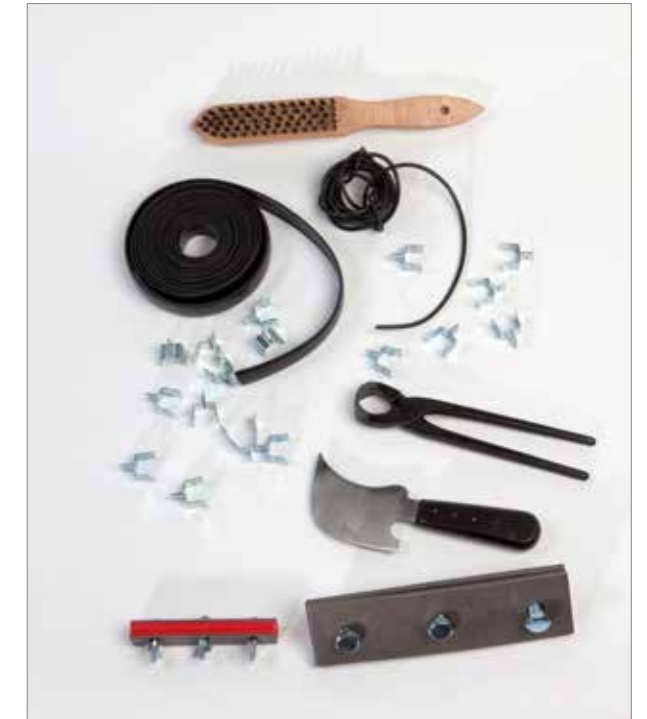

Welding of Sika® Waterbars Made of PVC-P, TPO and Tricomer®



Measuring, marking, cutting

Axe-shaped welding tool

Welding equipment type SG 320 L

Sparktester



Preparation of overlapping

Overlapping joint with hot air blower

Strengthening with welding foil using hot air gun

Strengthening with welding strip using welding tip

Equipment, Tools And Accessories

For the Vulcanizing of Sika® Waterbars Elastomer



Introduction

Joints of Sika® waterbars Elastomer (rubber) are made in a vulcanizing process. This process is irreversible, i.e. it can be carried out only once and therefore requires careful, consistent and complete execution of all of the working steps.

Standard junctions, e.g. flat cross, vertical T, flat edges etc. are all prefabricated in our factory using specialist equipment i.e. autoclaves. Therefore only the butt joints should be made on site.



Vulcanizing Equipment for Sika® Waterbars Elastomer

Vulcanizing equipment VG 450
with moulds, dependant on equipment and profiles
Vulcanizing equipment VG 600
with moulds, dependant on equipment and profiles

Vulcanizing Accessories

Vulcanizing Solvent
Adhesion foil
Strip type 0
Strip type 1
Bonding agent for steel/rubber
connections, including primer
Talcum
Plug

Tools

Special knife
Roller
Taping Rod
Grinder

Accessories

Waterbar clip type 2



Vulcanizing of Sika® Waterbars Elastomer



Measuring, marking, cutting



Grinding of the rubber surface



Applying the vulcanizing solution to the rubber surface



Plugging of the centre bulb with a cellular foam plug and inserting a raw rubber plug



Applying the adhesion strip



Jointing the waterstop, tightening with the fixing Clamps



Application of cover strips; pressing home of both cover strips



Powdering of waterstop and inserting into the vulcanizing equipment

Waterbar Specification

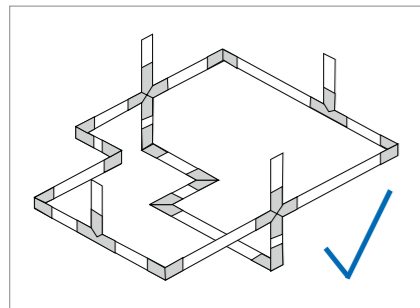

Closed Waterproofing System
Waterbars must create a closed waterproofing system within the reinforced concrete structure. Joint intersections with each other and with penetrations and edges of the structure should be made as square as possible. The clearance from the edges of the structure should generally be 0.5 m minimum. The overall waterbar section system specification and method statement for a project are divided into logical sections. These are linked to the drawings of the system and its components, their factory prefabrication or assembly and for their installation on site. This also provides part of the project documentation and confirmation of the specific waterbar qualities required. The waterbars should conform with the local regulations and specifications.

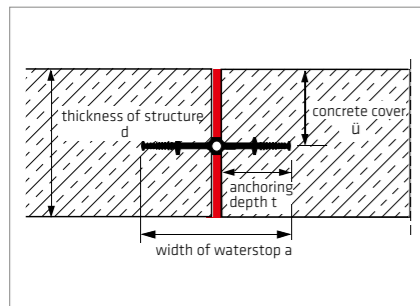

Waterbar Width Rule
The component thickness d around internal waterbars should be at least equivalent to the waterbar width a (embedment depth \leq cover). A component thickness of 300 mm is sufficient for 320 mm wide waterbars according to DIN 18541 (types D and A). The choice of waterbars is based on the load and exposure, e.g. in accordance with DIN V18197. Our Product Engineering department will be pleased to assist you in your projects.

Bending radius r	
	25 cm
	15 cm
	50 x Stop anchor depth f (Example: $f = 30 \text{ mm} \rightarrow r = 1,50 \text{ m}$)
	$\geq 30 \times$ Profilhöhe a (Example: $a = 70 \text{ mm} \rightarrow r = 2,10 \text{ m}$)
Otherwise Mitred angled joint (factory made joint)	

Bending Radius r
When there are changes of direction perpendicular to the waterbar level, waterbars may be bended strictly regarding the indicated minimum bending radius r . If the required bending radius r cannot be maintained, a factory-made vertical angle should be specified.

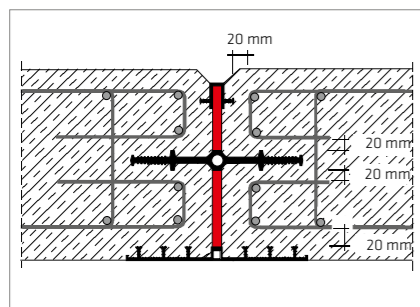
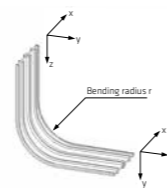

Concrete and Reinforcement Cover
The clearance between waterbar and reinforcement shall be at least 20 mm.

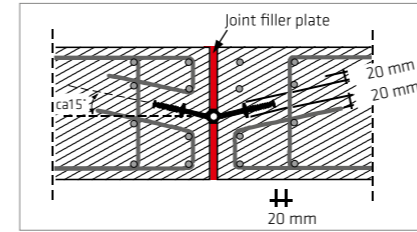

Horizontal Waterbar Installation in Slabs
Internal waterbars in horizontal base or deck slabs should be installed in a v-shape at an angle of about 15° upwards, to allow the waterbar sides to be embedded without voids and to prevent concrete honeycombing (from grout loss / segregation during concreting).

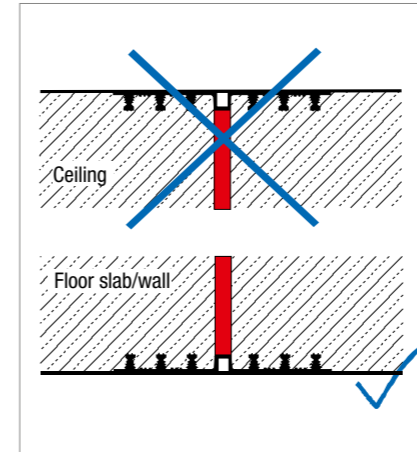

Use of External Waterbars
External waterbars are always fitted on the water contact side. They must not be casted in on the top of horizontal and low angled components (due to the risk of air entrapment and voids). External waterbars must be given adequate durable protection against mechanical damage (e.g. by backfilling with soil, sand, similar fillers without angular crushed stone).

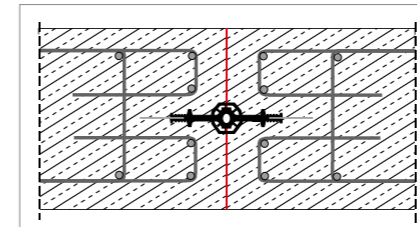

Design of Construction Joints
Expansion joint waterstops are also used in contraction joints. If shear movement can occur in a contraction joint, a deformation void must be created using an encased centre-bulb (e.g. waterstop type Tricosal® FMS 500 HS Elastomer).

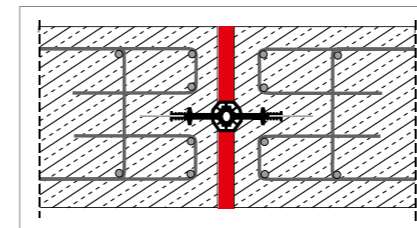

Design of Wide Joints
For expansion joints with a nominal joint width $W_{nom} \geq 30 \text{ mm}$ and if shear force $VY > W_{nom}$ occurs, measures must be taken to prevent any possible damage to the waterstop from the concrete edges (e.g. use encased centre-bulb waterstop type: Tricosal® FMS 500 HS Elastomer).

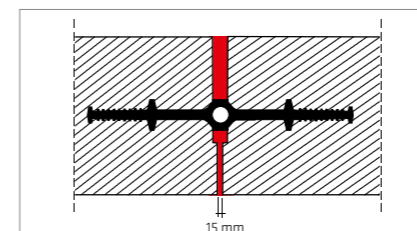

Minimum Joint Width
For the joints in service, under their intended deformation, the joint width at a nominal width of $W_{nom} = 20 \text{ mm}$ must not be less than 15 mm and at a nominal width of $W_{nom} = 30 \text{ mm}$, not less than 20 mm. Otherwise a deformation void must be created by forming an encased centre bulb (e.g. waterbar type Tricosal® FMS 500 HS Elastomer – see Contraction Joint above).

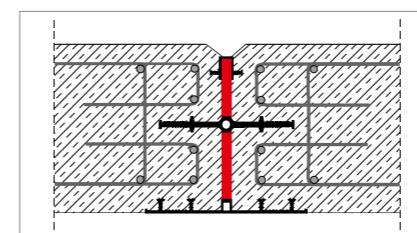

Joint Seal at Open and Below Ground Ends
To protect joints from contamination, external waterbar should be installed at below ground ends with a suitable joint sealant or capping waterbar at the open air ends.

Waterbar Handling Guidelines

Storage

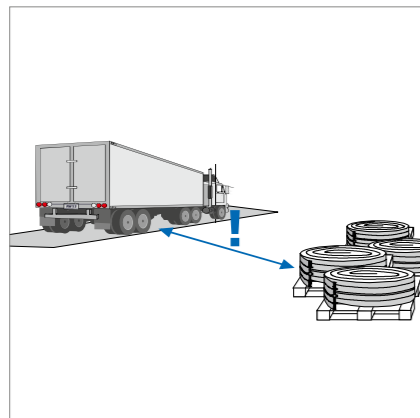

Protected Storage

When delivered to site, the waterbar products must be unloaded carefully and inspected immediately for completeness and integrity, including form and dimensions. Before installation the waterbars must be kept in a sheltered place on boards or some other firm base (e.g. pallets, concrete surfaces) and protected from contamination or damage.

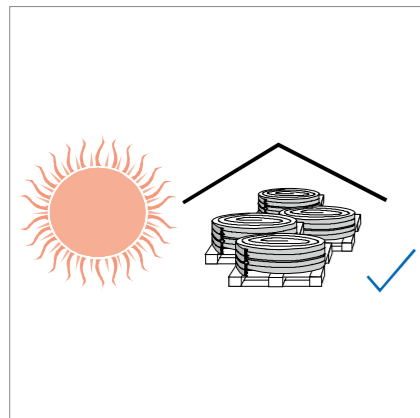

Storage in Summer

Waterbars must be protected from direct sunlight, specially in summer, e.g. by covering. In high outside temperatures waterbars must be taken to the point of installation and laid out under no tension.

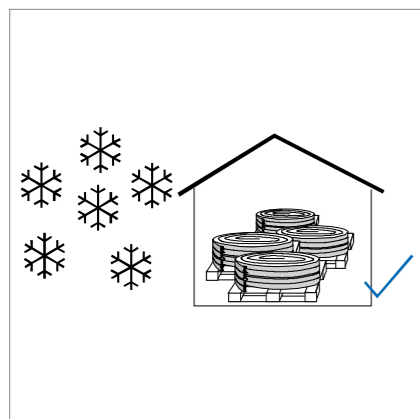

Storage in Winter

Waterbars should be kept in covered storage if possible and then be put in heated rooms for at least one full day prior to their installation, to make their handling and installation easier and less prone to damage (thermoplastic material).

Waterbar Installation Guidelines

Installation and Fixing

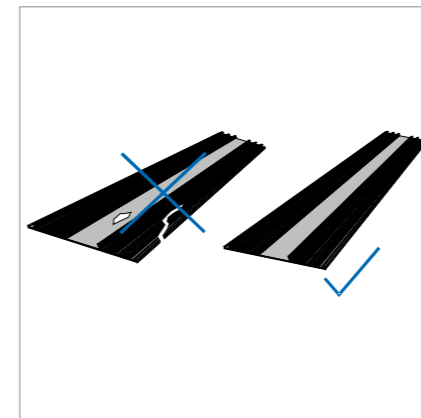

Cleanliness and Integrity

Waterbars must not be installed if they have suffered deformation or damage which might impair their function. Waterbars must be installed without creasing or distortion. Deformation in external PCV-P, TPO or Tricomer® waterbars caused during storage or handling (e.g. creasing or distortion of the anchors) should be corrected by stretching on a level base and heat treatment. Waterbars can only be installed at a material temperature of over ± 0 °C and in weather conditions not endangering the safe installation of the whole waterproofing system.

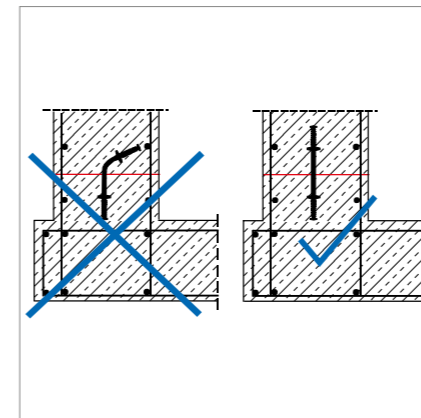

Fixed in a Stable Position

Waterbars should be installed in their specified position, symmetrical to the joint axis, and be fixed so that their position can not change or move during the concreting works.

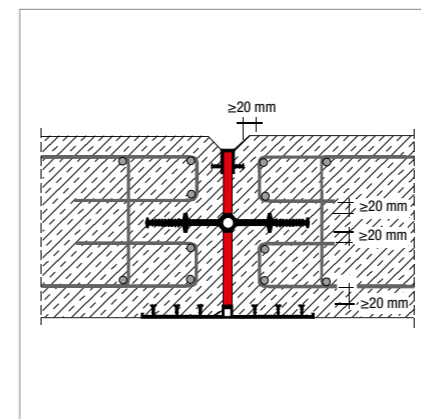

Concrete and Reinforcement Cover

The minimum clearance and concrete cover shall be at least 20 mm.

Waterbar Installation Guidelines

During the Waterbar Installation

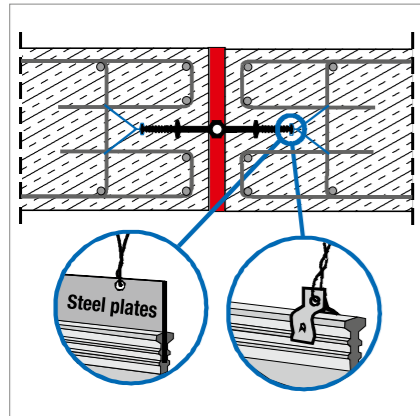

Fixing Internal Waterbars
Internal waterbars are anchored to the reinforcement. The waterbars are fixed to the edge anchors with the special waterbar clip or, in the case of waterbars with steel plates (FMS, FS) to the edge perforation of the steel plates at maximum intervals of 25 cm.

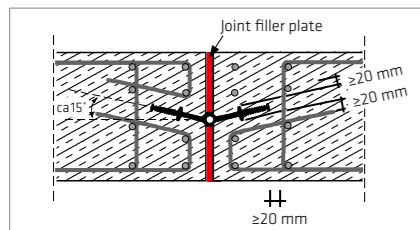

Horizontal Waterbar Positioning in Slabs
To prevent honeycombing or concreting voids, the internal waterbars in bases and decks should be installed in a v-shape at an angle of about $\geq 15^\circ$ upwards.

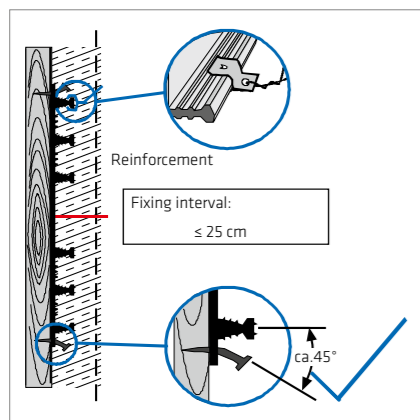

Fixing of External Waterbars
External waterbars for walls are fixed with nails to the formwork at the edges, nailing plates with an embedment depth maximum 1/3 of nail length and bent around approx. 45° . If there is a risk of a stop end anchor snapping (e.g. due to concrete dropping too heavily by mistake), it should be fixed to the reinforcement with waterbar clips every 25 cm, e.g. the top stop end anchors of the waterbar system in the base / wall joints. External waterbars for horizontal installation under bases are fixed directly to the concrete blinding.

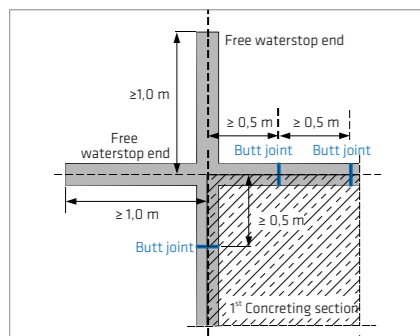

Spacing Between Joints in the Waterbars Themselves
The spacing between two joints in the waterbars themselves should be 0.50 m minimum. In every configuration the length of the free waterbar ends should be 1.00 m minimum so that these connection joints can be formed easily and correctly on site.

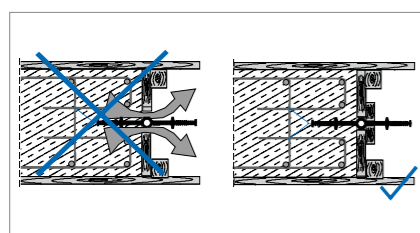

Tight Bulkhead Formwork
When installing the waterbar system, ensure that the bulkhead formwork is tight, stable and immovable. The stopend formwork must lie tight against the waterbars. The waterbar must be protected from damage before and during the concreting works.

Waterbar Installation Guidelines

During the Concreting Works

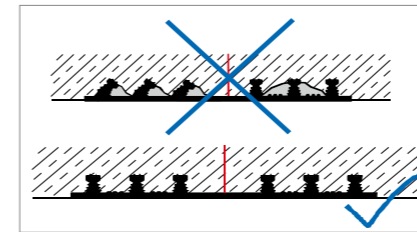

Embedding of External Waterbars
Waterbars must be free from contamination and ice when casted in. If necessary they should be cleaned before concreting (e.g. removal of any accumulated site debris such as sawdust, sand, concrete residues, cement laitance, oil, grease, snow, ice etc.). This is particularly important for external waterbars in the base of a structure.

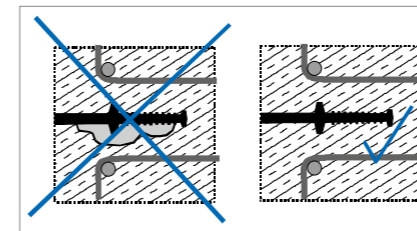

Casting Without Honeycombing or Voids
The waterbars must be fully enclosed in concrete and the concrete must be free from voids. Make sure that there is a low concrete drop height, good flow without segregation and even distribution.

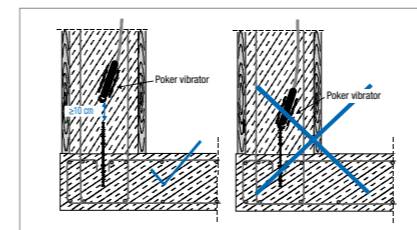

Clearance Between Poker Vibrators and Waterbars
The poker vibrators must never touch the waterbar or its fixings (minimum clearance ≥ 10 cm). It is usually preferable to compact around external waterbars with external vibrators, which will also give better compaction around stop end anchors.

Protection

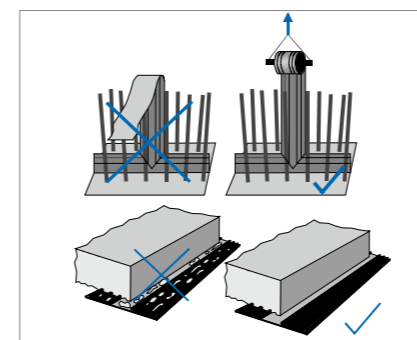

Protection of Exposed Waterbars On Site
The waterbars should be protected from damage until they are fully casted in. Examples of suitable protective measures are:

- For waterbars in walls: cover reinforcement ends with boarding, box in or roll up and suspend the waterbar till later
- For waterbars to be trafficked: completely cover or bed in sand
- For waterbar ends to be exposed for some time: box in to fully protect

Striking of Formwork

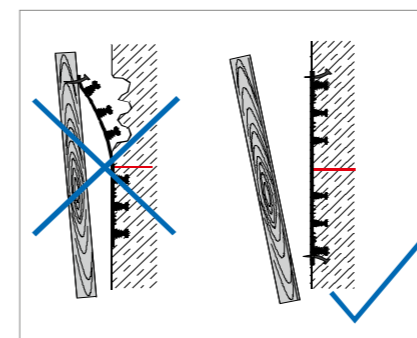

Striking Around External Waterbars
Take great care that external waterbars do not come loose during striking of adjacent or attached formwork. Extend the time before striking these areas if necessary.

Additional Information

Quality, support and service

Quality monitoring

All Sika waterproofing products are produced under ISO monitoring standards during production.

Our waterbars also undergo regular external monitoring in accordance with DIN Standard requirements in Germany by North Rhine Westphalia Materials Testing Institute (MPA NRW).

Dimensions/tolerances

Sika waterstop products are subject to the dimensional and tolerance requirements of the relevant German Standards, e.g. DIN 18541 and DIN 7865.

Certification

Test certificates with the materials physical and chemical properties can be supplied by agreement.

Support and service

With Sika's extensive expertise and experience in the development, production and practical installation of waterproofing systems and products, Sika personnel are well qualified to provide advice and assistance to owners and their professional design and construction teams on the selection of the most suitable waterproofing systems, engineered joint designs and configuration.

Sika provides design guidelines and tools, together with all necessary specifications, technical information, tender documents and on-site support so that the systems used to waterproof your project will perform as required and do their job reliably for the long term.

CAD drawings

CAD drawings are produced and available on request for designers and contractors to use for design, inspection, installation, invoicing and providing documentation on the waterproofing systems and details for specification and as-built drawings etc. as required.

Installation training courses

Sika provides frequent focussed technical and practical training courses to ensure the correct and professional installation of our waterproofing systems – from on-site induction to in-house courses over several days at our own training facilities.

Subcontract services

Sika Deutschland GmbH is a product manufacturer and does not provide installation services on site. However, this service is provided by specialist contractor partners that are specifically trained in each of the systems by Sika. For detailed information please contact your local Sika Company.

Disclaimer

All the information in this brochure, and, in particular, the suggestions and examples relating to the application and end-use of the products, are given in good faith based on our current knowledge and experience of the products when properly stored, handled and applied under normal conditions in accordance with our recommendations. In practice, the differences in materials, substrates and actual site conditions are such that no warranty in respect of merchantability or of fitness for a particular purpose, nor any liability arising out of any legal relationship whatsoever, can be inferred either from this information, or from any written recommendations, or from any other advice offered. The user of the product must test the product's suitability for the intended application and purpose. Sika reserves the right to change the properties of its products. The proprietary rights of third parties must be observed. All orders are accepted subject to our current terms of sale and delivery. Users must always refer to the most recent issue of the local Product Data Sheet for the product concerned, copies of which will be supplied on request.

Technical information and details

The drawings and details in this brochure are schematic and may vary according to the actual installation situation. The illustrations of the waterstops themselves are intended as graphic representations of the profiles mentioned.

Dimensional information

The dimensions in the tables are in mm (unless otherwise stated) and given as a guide.

Copyright

© 2020: Sika Deutschland GmbH
All rights reserved, including reprinting of extracts, photographic reproduction and translation.

Edition/version

05/2020

Notes

WORLDWIDE SYSTEM SOLUTIONS FOR CONSTRUCTION AND INDUSTRY



CONCRETE



WATERPROOFING



ROOFING



FLOORING



CORROSION AND FIRE PROTECTION



SEALING AND BONDING



REFURBISHMENT



BUILDING FINISHING



INDUSTRY

As a subsidiary of the globally operative Sika AG, Baar/Switzerland, Sika Deutschland GmbH is one of the leading suppliers of building chemical product systems as well as sealants and adhesives for industrial manufacturing.



SIKA DEUTSCHLAND GMBH
Kornwestheimer Straße 103-107
70439 Stuttgart
Germany

Tel. +49 711 8009 - 2171
Fax +49 711 8009 - 321
export@de.sika.com
www.sika.com

BUILDING TRUST

